

# Panel Guide

## 2023



## CONTENT

|                             |       |
|-----------------------------|-------|
| ROLL UP CLASSIC .....       | 3     |
| ROLL UP PROFESSIONAL.....   | 3     |
| ROLL UP COMPACT .....       | 3     |
| 4 SCREEN CLASSIC.....       | 3     |
| POLE SYSTEM.....            | 3     |
| POP UP MAGNETIC .....       | 4-6   |
| POP UP MAGNETIC TOWER.....  | 4-5   |
| CASE & COUNTER.....         | 7     |
| STANDARD CASE.....          | 7     |
| FABRIC SYSTEM .....         | 8-9   |
| LIGHT FRAME .....           | 10-11 |
| CLASSIC FRAME .....         | 12-14 |
| FABRIC STAND.....           | 15    |
| MONITOR STAND.....          | 15    |
| LIGHT FRAME MINI.....       | 16    |
| LIGHT FRAME COUNTER.....    | 16    |
| MAGNET FRAME.....           | 17    |
| PANEL BASE.....             | 18    |
| STAND UP.....               | 18    |
| SOFT IMAGE .....            | 19    |
| SOFT IMAGE COUNTER .....    | 19    |
| INFO STAND .....            | 20    |
| PORTABLE TABLE .....        | 20    |
| BROCHURE STAND.....         | 20    |
| BROCHURE STAND DOUBLE ..... | 20    |
| GRAPHIC PROFILE .....       | 20    |

VISIT [WWW.EXPOLINC.COM](http://WWW.EXPOLINC.COM) FOR SET-UP MOVIES AND DOWNLOADS

## Roll Up

| Product                            | Panel size standard | Visible size standard | Panel size telescopic rod | Visible size telescopic rod | Weight |
|------------------------------------|---------------------|-----------------------|---------------------------|-----------------------------|--------|
| <b>Roll Up Classic 700</b>         | 700 x 2200          | 700 x 1950            | x                         | x                           | 3,9    |
| <b>Roll Up Classic 850</b>         | 850 x 2400          | 850 x 2150            | 850 x 2490                | 850 x 1625 - 2240           | 4,5    |
| <b>Roll Up Classic 1000</b>        | 1000 x 2400         | 1000 x 2150           | 1000 x 2490               | 1000 x 1625 - 2240          | 5,2    |
| <b>Roll Up Classic 1150</b>        | 1150 x 2400         | 1150 x 2150           | 1150 x 2490               | 1150 x 1625 - 2240          | 5,8    |
| <b>Roll Up Classic 1450</b>        | 1450 x 2400         | 1450 x 2150           | x                         | x                           | 7,3    |
| <b>Roll Up Professional 850</b>    | 850 x 2400          | 850 x 2150            | x                         | x                           | 4,8    |
| <b>Roll Up Professional Double</b> | 850 x 2400          | 850 x 2150            | x                         | x                           | 7,3    |
| <b>Roll Up Compact 850</b>         | x                   | x                     | 850 x 2420                | 850 x 1605 - 2200           | 3,4    |
| <b>Roll Up Compact 1000</b>        | x                   | x                     | 1000 x 2420               | 1000 x 1605 - 2200          | 3,7    |

Maximum panel thickness is 440 micron. When using 2450 mm supporting rod or stiff material, the recommended thickness is 270-330 micron. When using 2450 mm supporting rod add 300 mm to the panel size. If uncertain we recommend to make tests with different materials.

## 4 Screen Classic

| Product                      | Panel size  | Visible size | Weight |
|------------------------------|-------------|--------------|--------|
| <b>4 Screen Classic 550</b>  | 550 x 1495  | 550 x 1481   | 1,9    |
| <b>4 Screen Classic 700</b>  | 700 x 1960  | 700 x 1946   | 2,2    |
| <b>4 Screen Classic 850</b>  | 850 x 2160  | 850 x 2146   | 2,5    |
| <b>4 Screen Classic 1000</b> | 1000 x 2160 | 1000 x 2146  | 2,7    |
| <b>4 Screen Classic 1150</b> | 1150 x 2160 | 1150 x 2146  | 4,1    |
| <b>4 Screen Classic 1450</b> | 1450 x 2160 | 1450 x 2146  | 4,7    |
| <b>4 Screen Classic 2000</b> | 2000 x 2160 | 2000 x 2146  | 5,3    |

4 Screen can handle most materials up to 450 micron thickness (paper, vinyl, pvc, textile). When using 2450 mm supporting rod add 300 mm to the panel size.

## Pole System

| Product                 | Panel size width | Panel size height  | Weight |
|-------------------------|------------------|--------------------|--------|
| <b>Pole System 550</b>  | 550              | optional, max 2400 | 2,6    |
| <b>Pole System 700</b>  | 700              | optional, max 2400 | 2,7    |
| <b>Pole System 850</b>  | 850              | optional, max 2400 | 2,8    |
| <b>Pole System 1000</b> | 1000             | optional, max 2400 | 2,9    |

Pole System can also be used as double sided. In this case an extra panel profiles should be added. Pole System can handle most materials up to 450 micron thickness (paper, vinyl, pvc, textile). Total height of the system is min 1000 mm and maximum 2560 mm.

## Panel profile dimension sketch

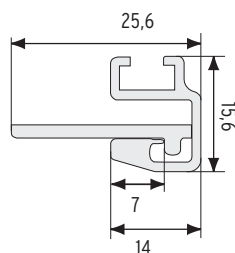

## Pop Up Magnetic - panel sizes

### Curved system

| Product              | Standard height | 2,5 m height | 3 m height |
|----------------------|-----------------|--------------|------------|
| Curved, inside       | 673x2224        | 673x2485     | 673x2957   |
| Curved, outside      | 808x2224        | 808x2485     | 808x2957   |
| Side panel, curved   | 673x2224        | 673x2485     | 673x2957   |
| Side panel, straight | 293x2224        | 293x2485     | 293x2957   |

### Straight system

| Product              | Standard height | 2,5 m height | 3 m height |
|----------------------|-----------------|--------------|------------|
| Straight panel       | 733x2224        | 733x2485     | 733x2957   |
| Side panel, curved   | 733x2224        | 733x2485     | 733x2957   |
| Side panel, straight | 293x2224        | 293x2485     | 293x2957   |

### Connected systems

| Product                              | Standard height | 2,5 m height | 3 m height |
|--------------------------------------|-----------------|--------------|------------|
| Straight connection                  | 733x2224        | 733x2485     | 733x2957   |
| 90° connection with panel, inside    | 265x2224        | 265x2485     | 265x2957   |
| 90° connection with panel, outside   | 733x2224        | 733x2485     | 733x2957   |
| 90° connection with profile, outside | 531x2224        | 531x2485     | 531x2957   |

## Pop Up Magnetic - weights

| Product     | Basic  |          | Travel |          | Standard |          | Case & Counter* |          | Top shelf |
|-------------|--------|----------|--------|----------|----------|----------|-----------------|----------|-----------|
|             | Curved | Straight | Curved | Straight | Curved   | Straight | Curved          | Straight | C&C       |
| Package 2x3 | 8,5    | 8,8      | 15,5   | 15,8     | 23,0     | 23,3     | 26,5            | 26,8     | 5,3       |
| Package 3x3 | 10,4   | 10,8     | 18,0   | 18,4     | 25,5     | 25,9     | 29,0            | 29,4     | 5,3       |
| Package 4x3 | 12,3   | 12,8     | 20,0   | 23,5     | 27,5     | 28,0     | 31,0            | 31,5     | 5,3       |

\*The top shelf is not included in the Case & Counter package.

## Pop Up Tower

| Product              | Qty panels | Panel size | Diameter | Weight |
|----------------------|------------|------------|----------|--------|
| Tower 3 squares high | 3 pcs      | 673x2224   | 643      | 5,5    |

Tower panel thickness should be 350 - 420 micron, as they should be pliable. These panels should not have kickers.

## Pop Up Magnetic - accessories

| Product | Standard height + recommended width |
|---------|-------------------------------------|
| Curtain | 2215 x 1300                         |

| Product       | Maximum load straight system | Maximum load curved system | Weight |
|---------------|------------------------------|----------------------------|--------|
| Screen Holder | 6,00*                        | 8,00                       | 1,1    |
| Shelf Kit     | 4,65*                        | 6,65                       | 2,4    |

\* Stabilizing feet code 7365 should be used for straight system. Screen Holder and Shelf Kit may only be used with Expolinc Pop Up Magnetic.

## Pop Up Magnetic - dimension sketches

### Example 3 squares

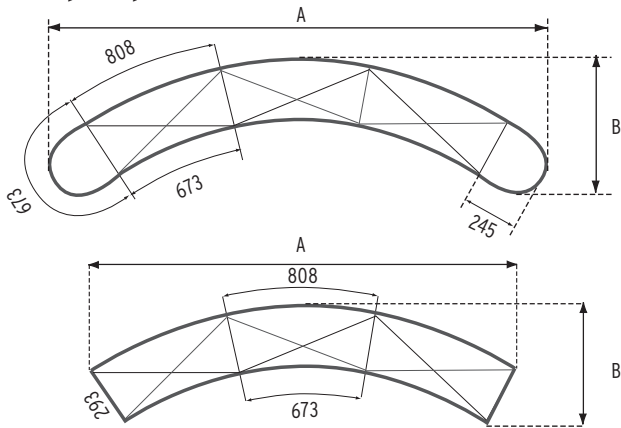

### Curved system

| Width     | Curved side panels |      | Straight side panels |      |
|-----------|--------------------|------|----------------------|------|
|           | A                  | B    | A                    | B    |
| 1 square  | 1225               | 375  | 846                  | 350  |
| 2 squares | 1915               | 510  | 1607                 | 461  |
| 3 squares | 2535               | 710  | 2290                 | 639  |
| 4 squares | 3065               | 970  | 2860                 | 877  |
| 5 squares | 3600               | 1250 | 3289                 | 1161 |

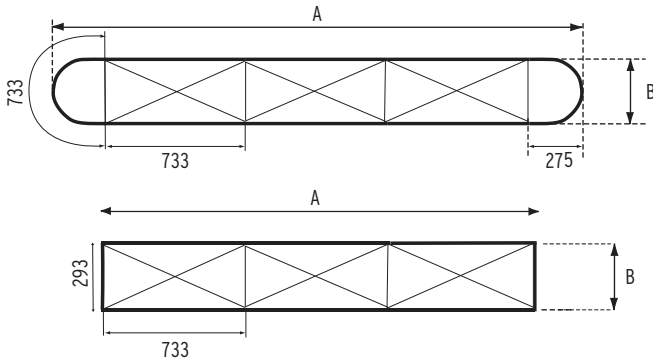

### Straight system

| Width     | Curved side panels |     | Straight side panels |     |
|-----------|--------------------|-----|----------------------|-----|
|           | A                  | B   | A                    | B   |
| 1 square  | 1283               | 315 | 779                  | 315 |
| 2 squares | 2016               | 315 | 1512                 | 315 |
| 3 squares | 2749               | 315 | 2245                 | 315 |
| 4 squares | 3482               | 315 | 2978                 | 315 |
| 5 squares | 4215               | 315 | 3711                 | 315 |

### Straight connection

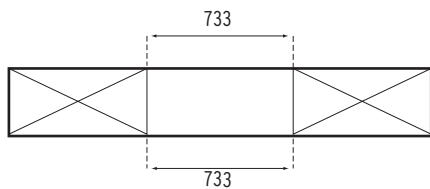

### 90° connection with panel

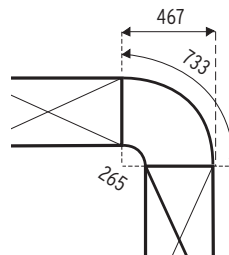

### with profile

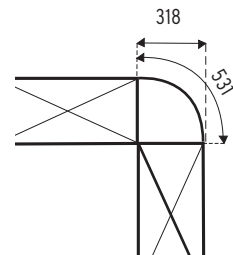

### Radius

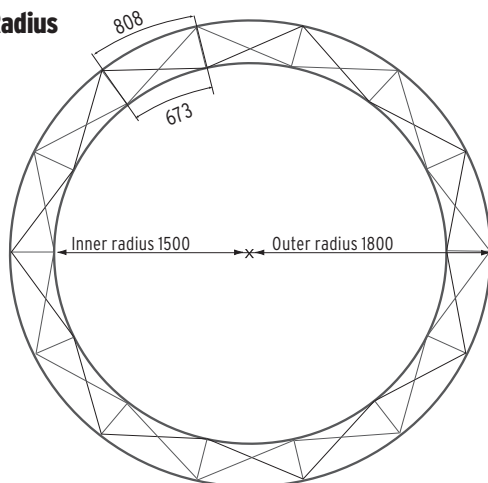

### Tower

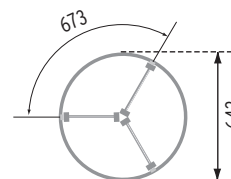

## Screen Holder & Shelf kit

### Position of holes in panel for Screen Holder/Shelf kit

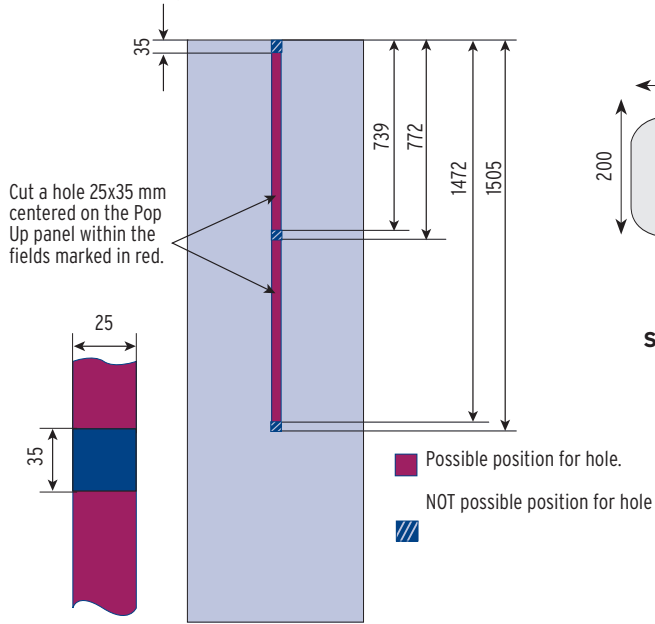

### Shelf Kit

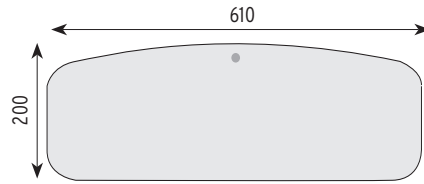

### Screen plate & VESA 100 & 200 Hole spacing

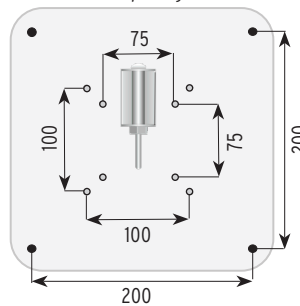

### Screen Holder

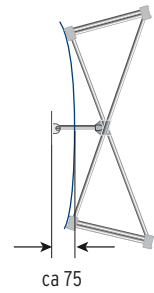

### Suspension options

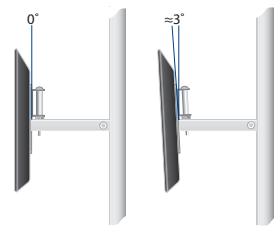

## Showcase

### Standard height

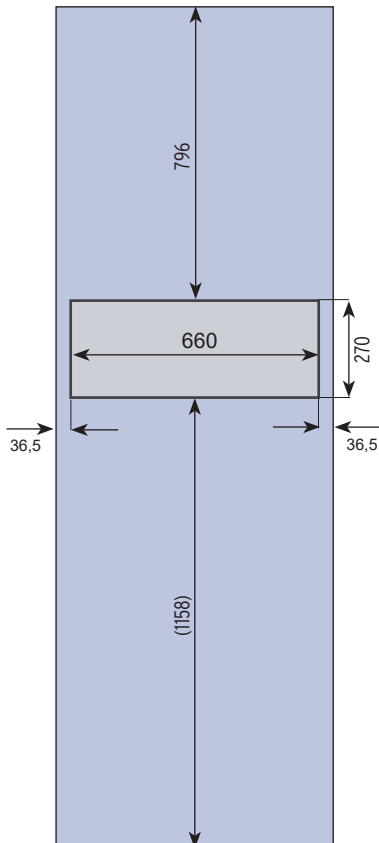

### 2,5 m height

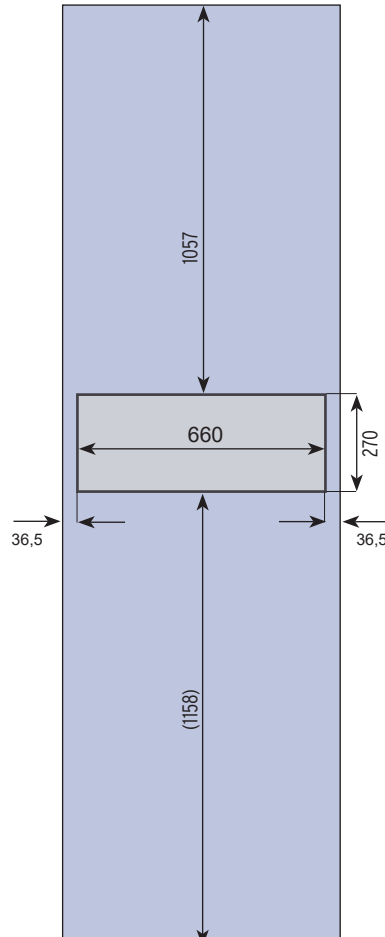

### Panel size - backpanel

**Minimum size 733x320**  
Also add the required quantity of magnetic bars for the backpanel.

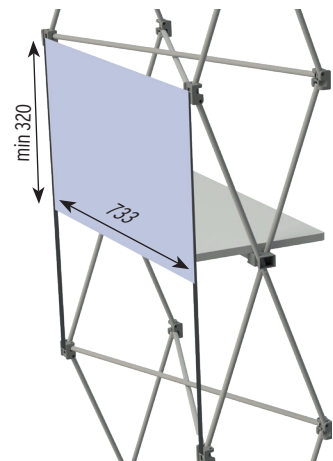

## Transport boxes

| Product                          | Panel size | Weight |
|----------------------------------|------------|--------|
| <b>Case &amp; Counter</b>        | 1820 x 920 | 16,5*  |
| <b>Double Case &amp; Counter</b> | 2880 x 920 | 33*    |
| <b>Standard Case</b>             | 1585 x 840 | 10,8   |

\*Top shelf is not included in Case & Counter. Weight top shelf 5.3 kg, top shelf double Case & Counter 7.3 kg.  
Recommended panel thickness 350 - 420 micron.

### Case & Counter

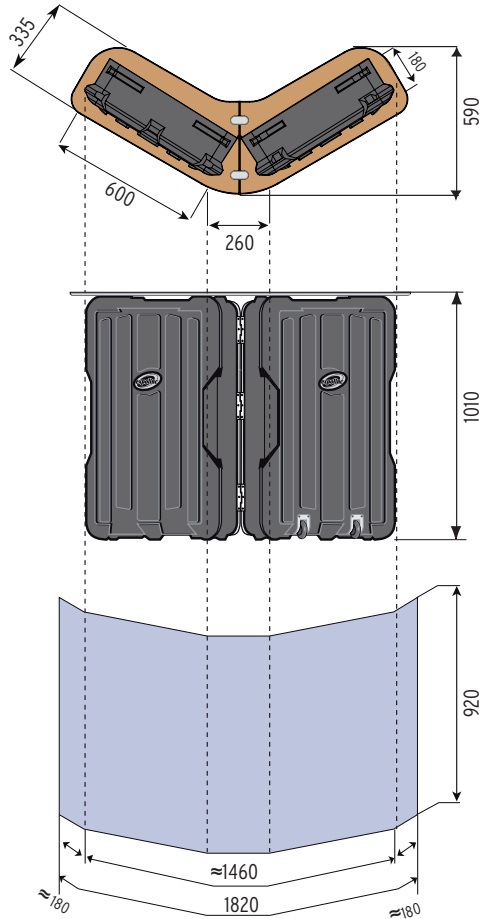

### Standard Case

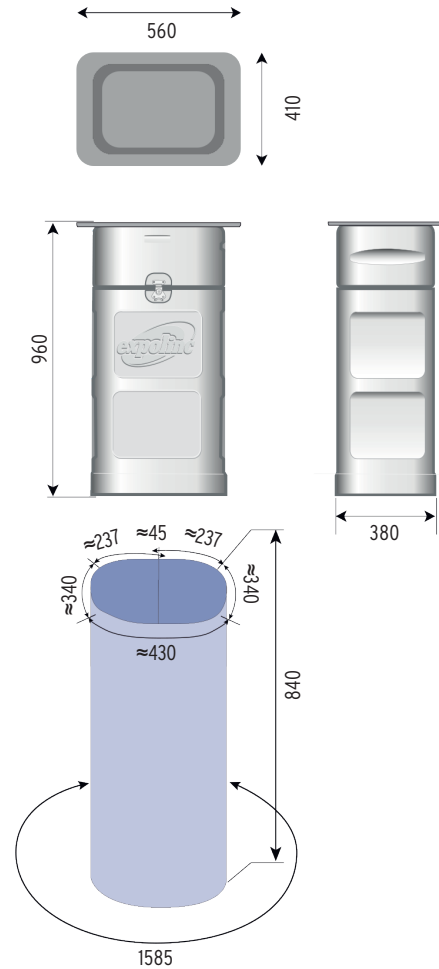

### Double Case & Counter

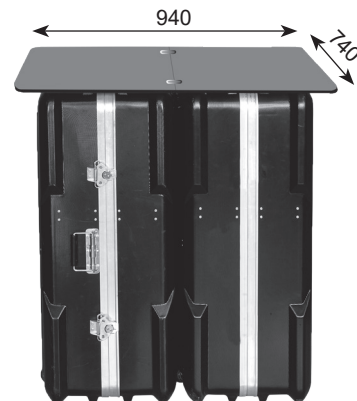
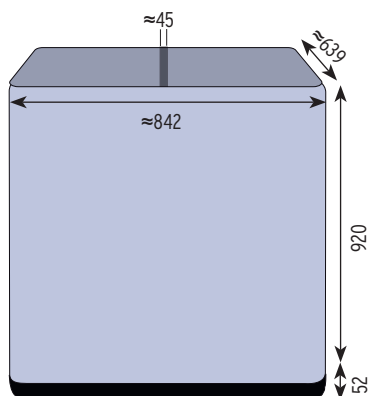

## Fabric System

| Product                            | Max building width mm | Graphic height mm | Graphic width mm      |
|------------------------------------|-----------------------|-------------------|-----------------------|
| <b>2 Poles straight</b>            | 3300                  | 1000 - 2750       | Profile lengths+sides |
| <b>2 Poles curved 15°</b>          | 3300                  | 1000 - 2750       | Profile lengths+sides |
| <b>3 Poles curved 15°</b>          | 6600                  | 1000 - 2750       | Profile lengths+sides |
| <b>3 Poles straight</b>            | 6600                  | 1000 - 2750       | Profile lengths+sides |
| <b>3 Poles curved 90°+straight</b> | 6800                  | 1000 - 2750       | Profile lengths+sides |

Max system height 2900 mm

### Profile lengths

|   |             |
|---|-------------|
| <b>Straight profile, can be cut into desired length</b> | <b>1100</b> |
| <b>Curved profile 15°, inner radius</b>                 | 1100        |
| <b>Curved profile 15°, outer radius</b>                 | 1100        |
| <b>Curved profile 90°, inner radius</b>                 | 1300        |



**Curved profile 15° 1100 mm**  
Graphic on outer radius 4,2 m.



**Curved profile 15° 1100 mm**  
Graphic on inner radius 4,2 m.



**Straight profile 1100 mm**  
Can be cut into desired length.

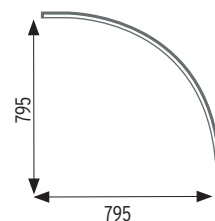

**90° inner curve 1300 mm**  
Graphic on inner radius 0,8 m.

| Weight packages                          | Weight* |
|--|---------|
| <b>Soft bag and 2 poles</b>              | 16,50   |
| <b>Standard Case XL and 2 poles</b>      | 29,00   |
| <b>Standard Case XL and 3 poles</b>      | 35,00   |
| <b>Profiles, straight and curved 15°</b> | 0,50    |
| <b>Profile curved 90°</b>                | 0,55    |

\*Weight excl profiles. Combine packages for larger building widths.



Recommended size of the graphic strip is 3x12mm in soft PVC or silicone.



Add 100 mm on each side to fold sides + seams at the top and bottom.

## Standard Case XL

| Product                 | Panel size           | *Weight kg | Weight top shelf |
|-------------------------|----------------------|------------|------------------|
| <b>Standard Case XL</b> | 1585 x 840           | 11,5       | 2,5 kg           |
| <b>Standard Case XL</b> | 1585 x 1075 with lid | 11,5       | 2,5 kg           |

Recommended panel thickness 350 - 420 micron. \*Top shelf, locking kit and papertube for panel are not included in Standard Case XL.

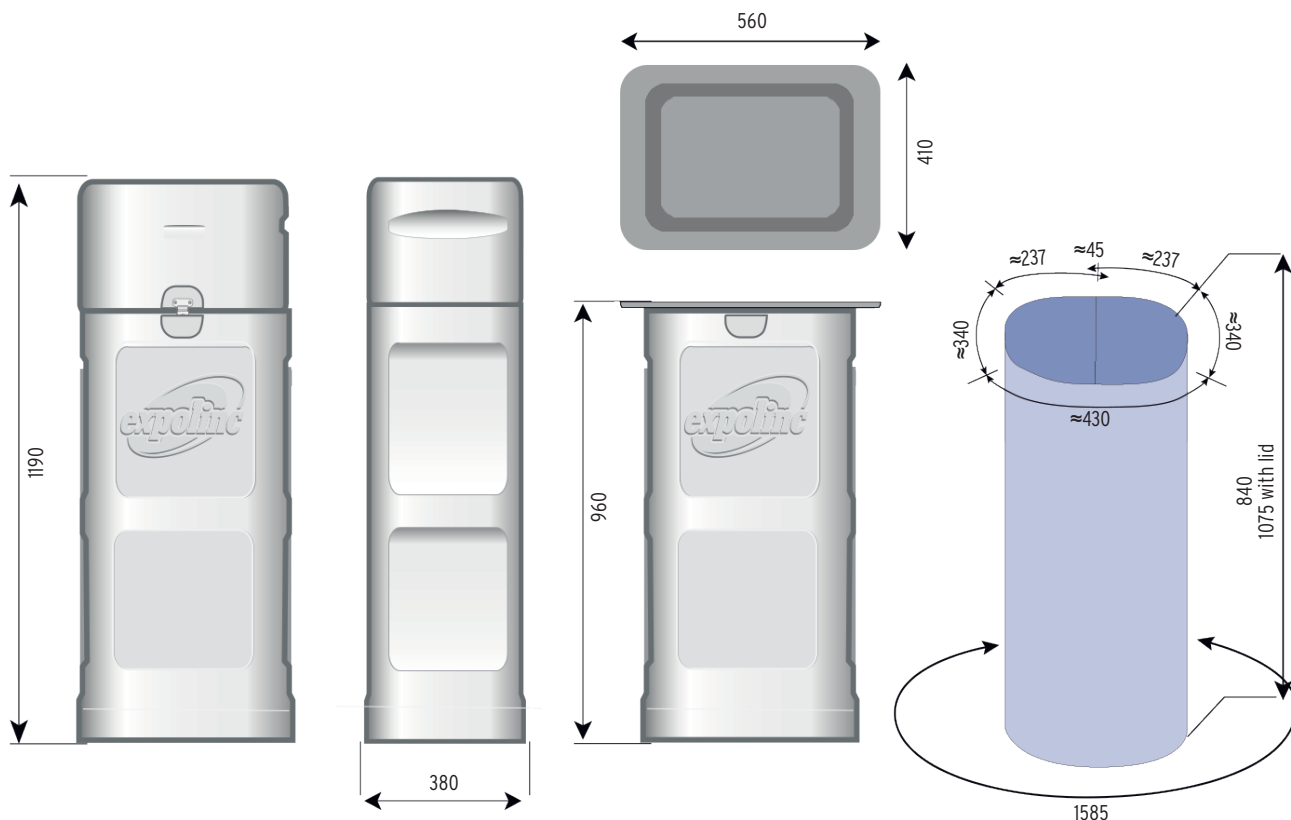



## Some examples

Top and bottom profiles



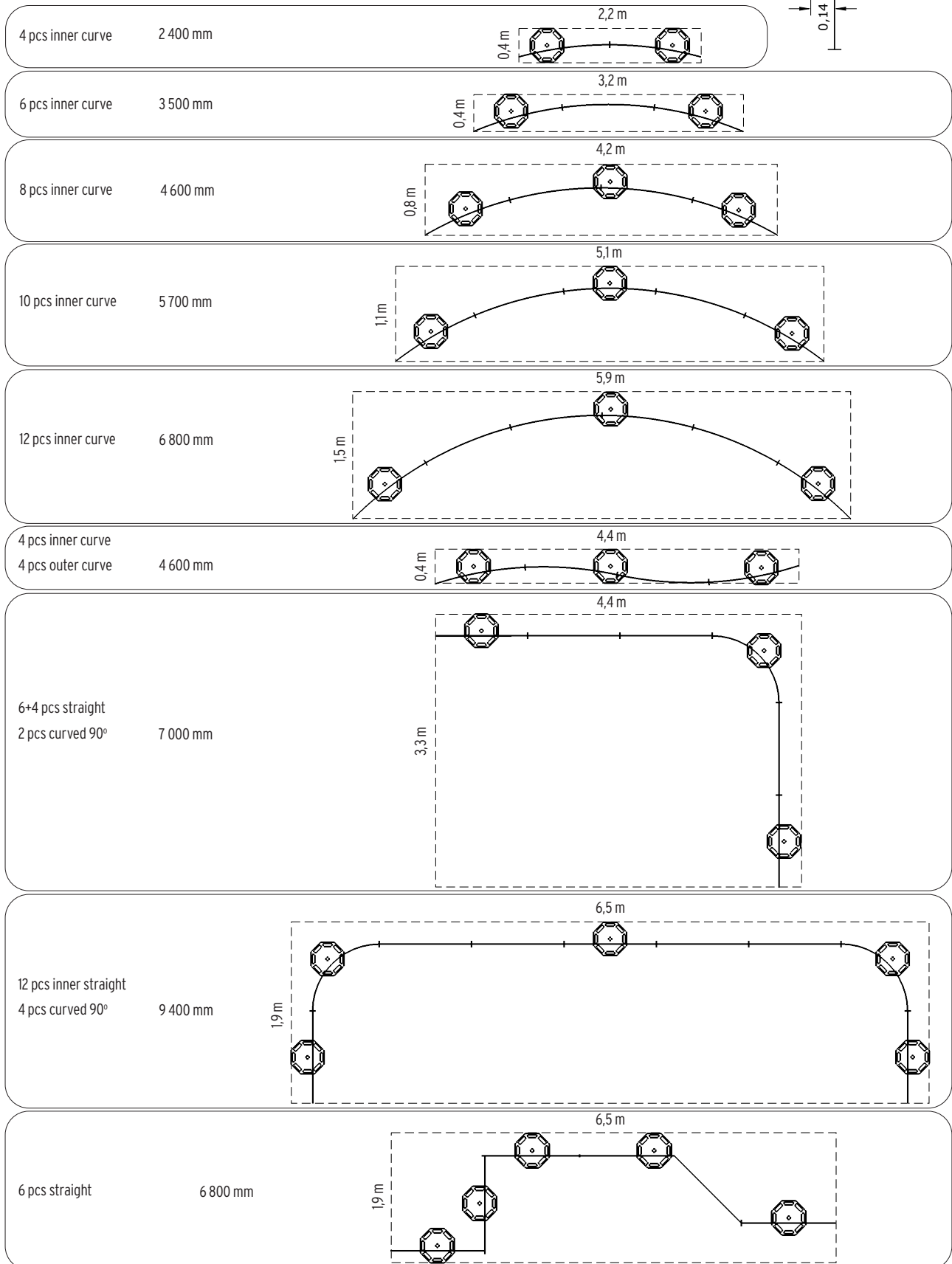
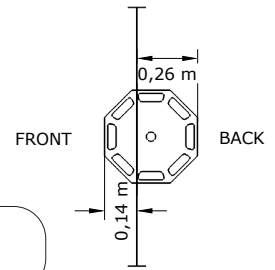

Graphic width inl 10 mm on each side

Total curve 30-45-60-75  
resp 90 degrees



# LIGHT Frame

## Profiles

|                      |   |        |
|----------------------|---|--------|
| <b>Light Profile</b> |  | 875 mm |
| <b>Profile 553</b>   |  | 553 mm |
| <b>Profile 803</b>   |  | 803 mm |
| <b>Profile 969</b>   |  | 969 mm |

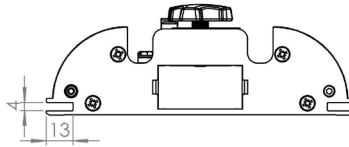

## Packages

**Weight**  
Basic/Standard Case/Travel

|                  |                |
|------------------|----------------|
| <b>962x2495</b>  | 28,5/N/A/27,3  |
| <b>1937x2495</b> | 35,4/40,2/33,5 |
| <b>2712x2495</b> | 42,5/46,2/39,5 |
| <b>3587x2495</b> | 50/53,1/46,4   |

Recommended max size for silicone or pvclist 14 x 3 mm

## Graphic sizes - frame outer measurements

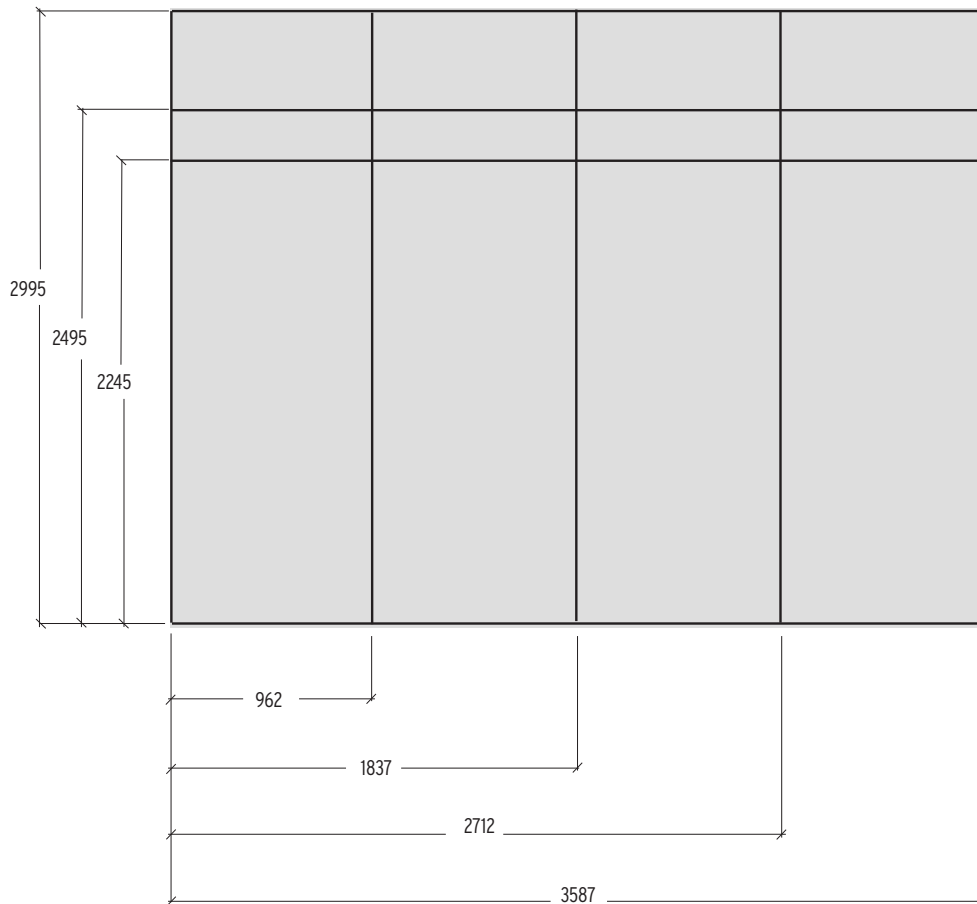

## Examples

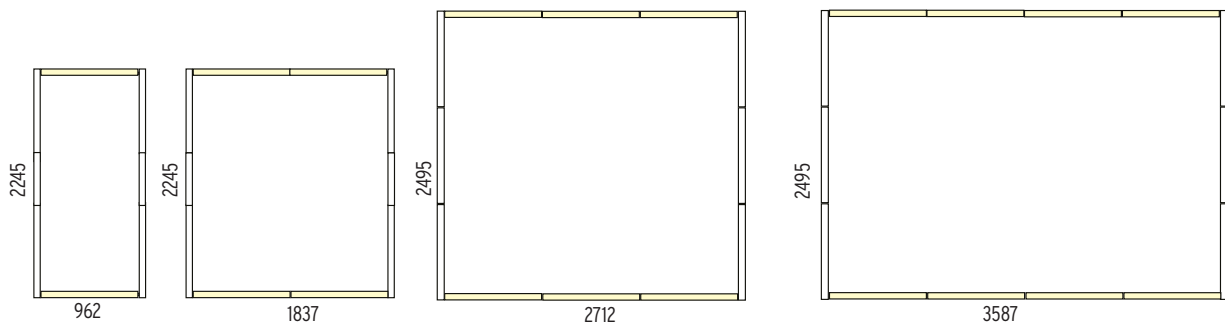

## Connectors

45 mm of the graphic will be hidden when connecting Frames in 90°.

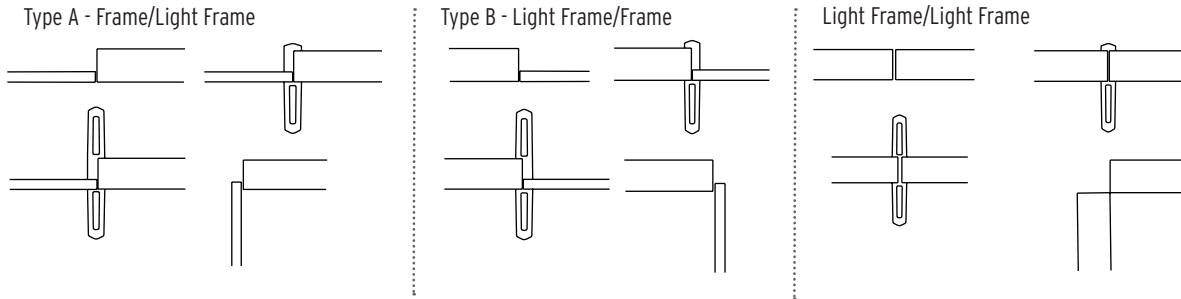

### Example - graphic sizes

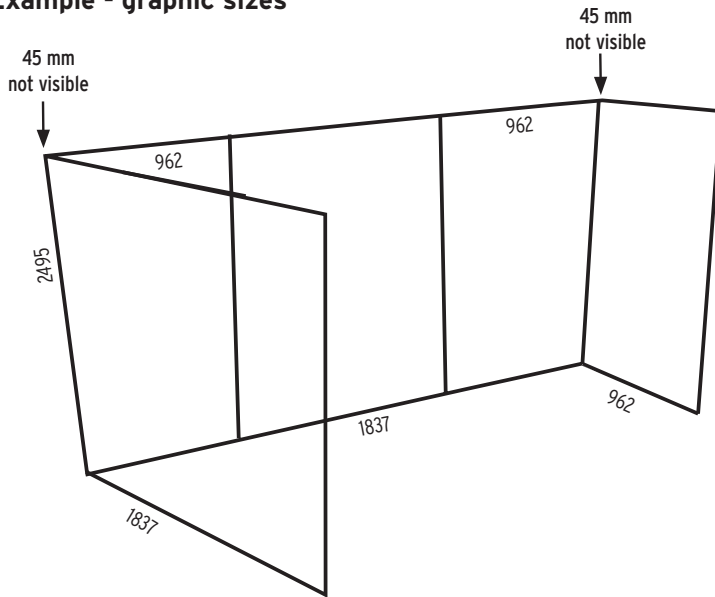

### Content

- 2 pcs 1837x2495
- 3 pcs 962x2495
- 2 pcs Connector 90°
- 2 pcs Connector straight,

## Stabilising feet

| Product                                  | Weight |
|--|--------|
| Double sided foot, pair (right and left) | 4,1    |
| Double sided foot, single                | 2,1    |
| Single sided foot, pair (right and left) | 3,4    |
| Single sided foot, left                  | 1,7    |
| Single sided foot, right                 | 1,7    |
| Double sided connecting foot             | 2,1    |
| Single sided connecting foot             | 1,7    |

### Supporting feet, double sided and single sided

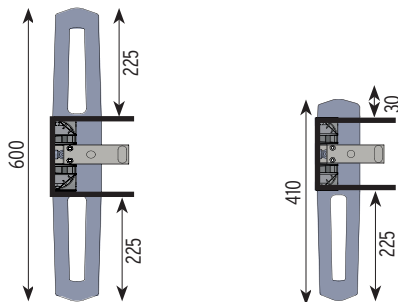

### Connecting feet, double sided and single sided

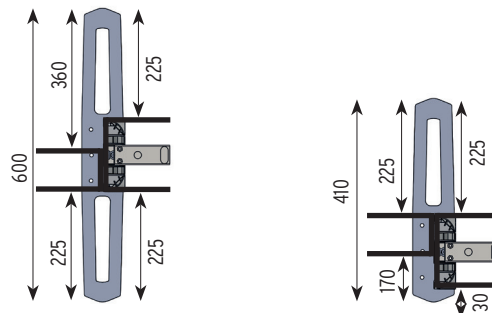

## Classic Frame

### Profiles

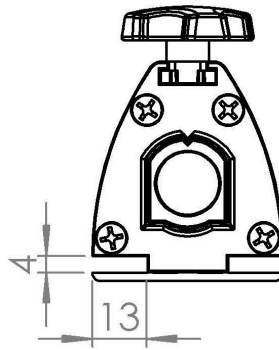
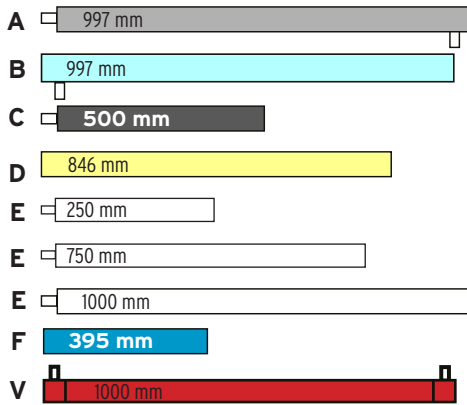

### Packages

Weight  
Basic/Travel/Standard Case XL

| Packages  | Weight         |
|-----------|----------------|
| 500x2495  | 9,5/NA/NA      |
| 950x2495  | 10,4/NA/NA     |
| 1950x2495 | 13,4/15,9/23,9 |
| 2950x2495 | 16,5/19,0/27,0 |
| 3950x2495 | 20,4/22,9/30,9 |
| 4950x2495 | 25,0/27,5/35,5 |

Recommended max size for silicone or pvclist 14 x 3 mm

### Graphic sizes - frame outer measurements

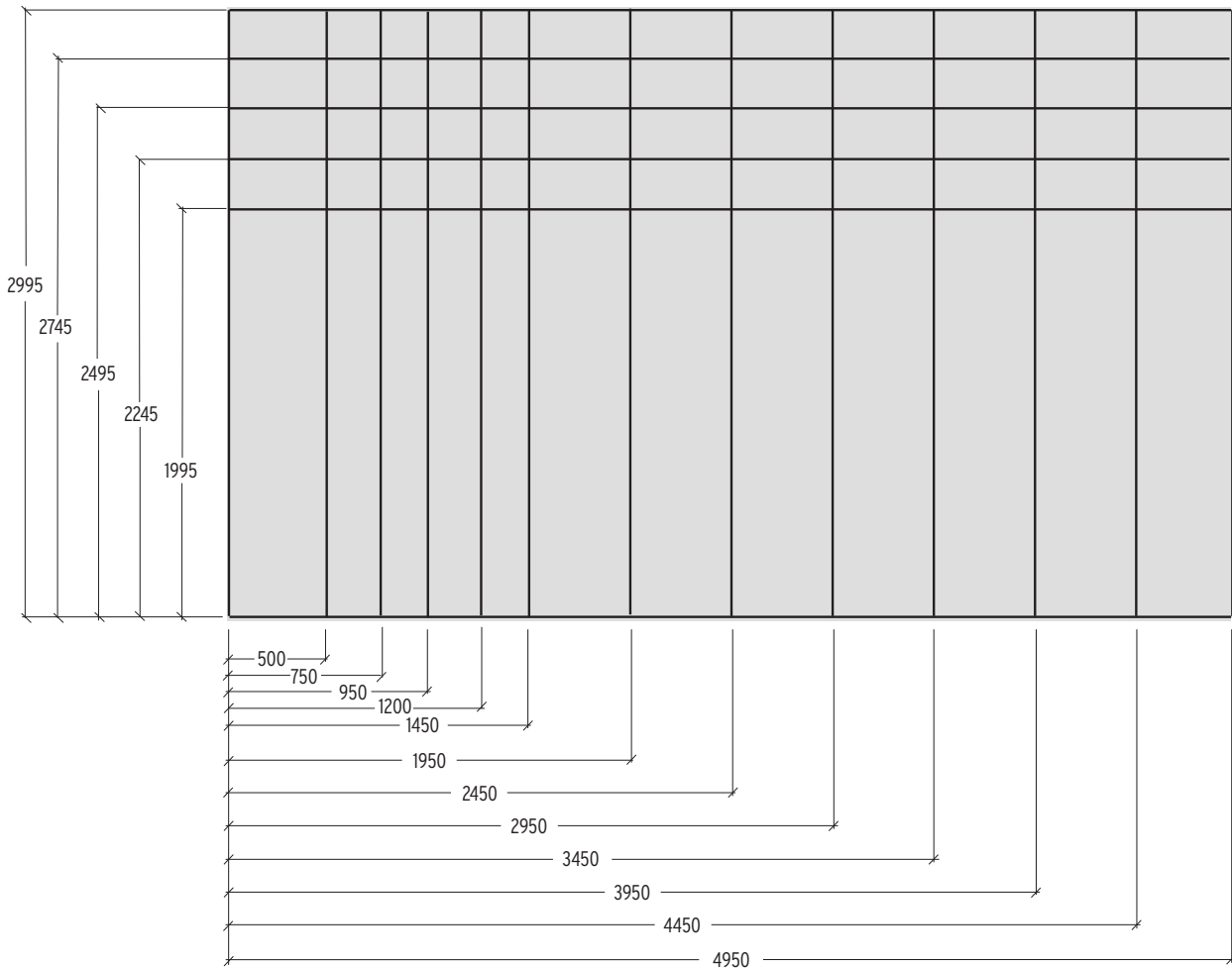

### Examples

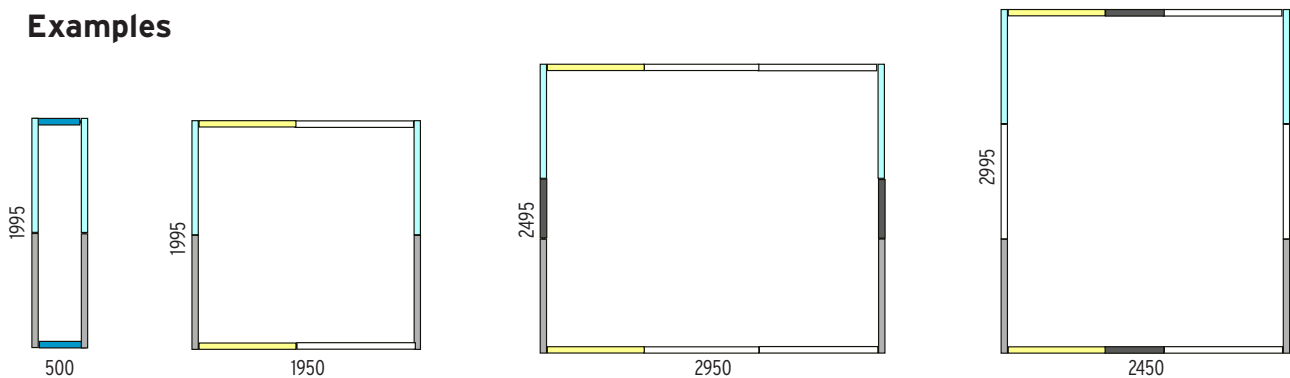

## Connectors

With connectors A-C 45 mm of the graphic will be hidden behind the connecting profile.

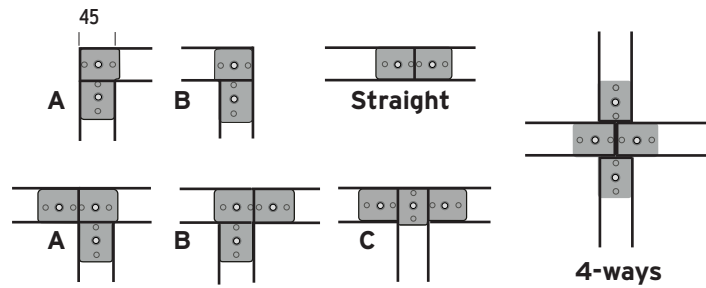

## Example - Frame outer measurements

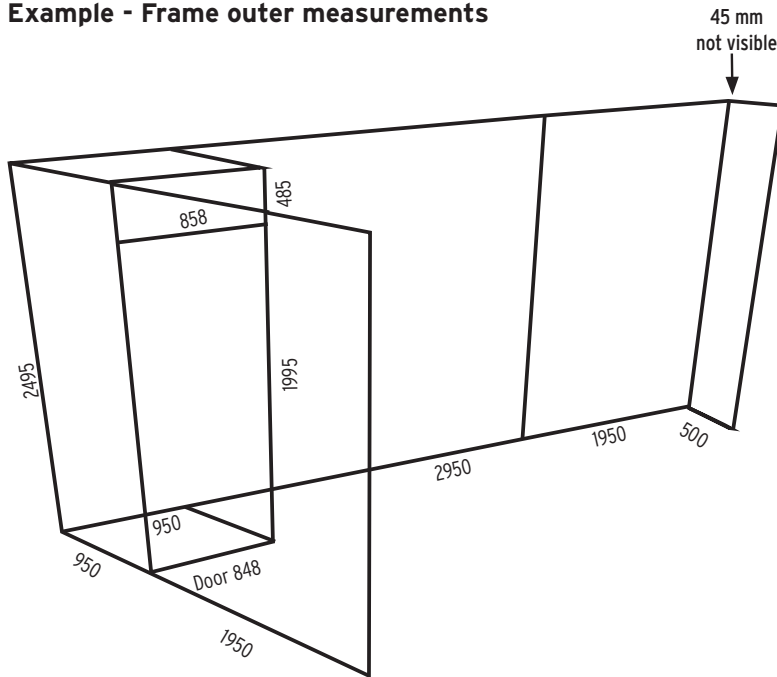

### Content

- 2 pcs 1950x2495
- 1 pc 2950x2495
- 1 pc 500x2495
- 1 storage room, left hung door
- Connector 90° type B

## Stabilising feet

| Product   | Weight |
|---|--------|
| Single sided foot   | 1,30   |
| Double sided foot   | 1,80   |
| Connecting foot, single sided incl upper straight connector | 1,35   |
| Connecting foot, double sided incl upper straight connector | 1,85   |

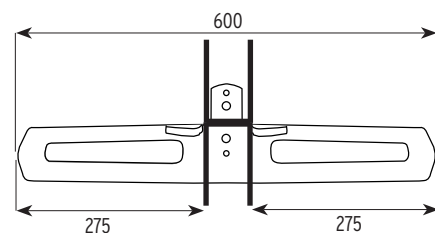
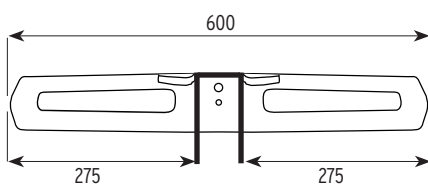
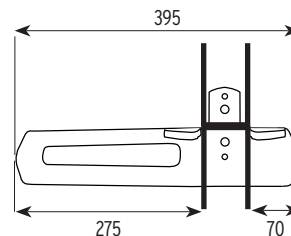
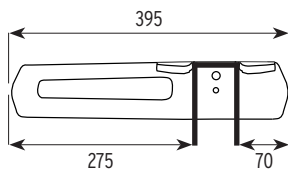

## Classic Frame - Storage room

| Product                        | Weight |
|--------------------------------|--------|
| Storage Room - Standard 2500mm | 47     |
| Storage Room - Standard 3000mm | 55     |
| Storage Room - XL 2500mm       | 63     |
| Storage Room - XL 3000mm       | 69     |

### Storage Room - Standard - Outer frame sizes

|                            |            |
|----------------------------|------------|
| 2500mm - Side              | 950 x 2495 |
| 2500mm - Door              | 848 x 1995 |
| 2500mm - Header above door | 858 x 485  |
| 3000mm - side              | 950x2995   |
| 3000mm - Door              | 848x1995   |
| 3000mm - Header above door | 858x985    |

#### Standard 2500mm

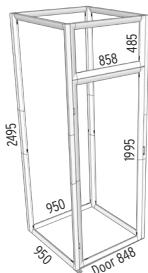

#### Standard 3000mm

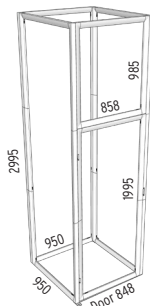

#### XL 2500mm

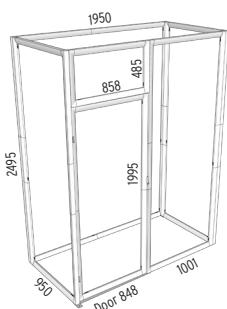

#### XL 3000mm

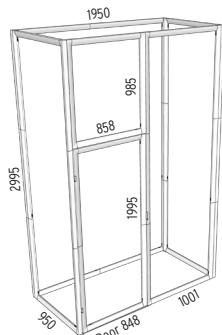

### Storage Room - XL - Outer frame sizes

|                            |             |
|----------------------------|-------------|
| 2500mm - Side              | 950 x 2495  |
| 2500mm - Side              | 1001 x 2495 |
| 2500mm - Side              | 1950 x 2495 |
| 2500mm - Door              | 848 x 1995  |
| 2500mm - Header above door | 858 x 485   |
| 3000mm - Side              | 950 x 2995  |
| 3000mm - Side              | 1001 x 2995 |
| 3000mm - Side              | 1950 x 2995 |
| 3000mm - Door              | 848 x 1995  |
| 3000mm - Header above door | 858 x 985   |

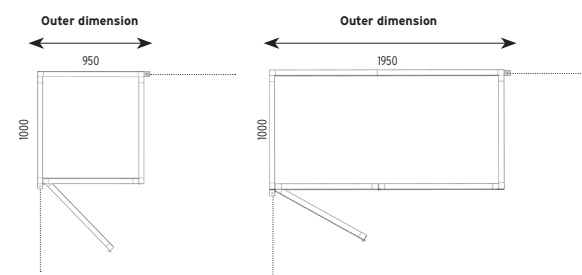

## Classic Frame - Counter

| Product  | No of graphics | Outer frame sizes | Weight* |
|--|----------------|-------------------|---------|
| Classic Frame - counter, 2 m in Standard Case XL | 1 pc front     | 1950x988          | 44      |
|  | 2 pcs sides    | 338x988           |         |
| Classic Frame - counter, 1 m in Standard Case XL | 1 pc front     | 950x988           | 33,5    |
| Classic Frame - counter, 1 m in Soft Bag         | 1 pc front     | 950x988           | 24,5    |
|  | 2 pcs sides    | 338x988           |         |

\*Weight incl. Standard Case XL.

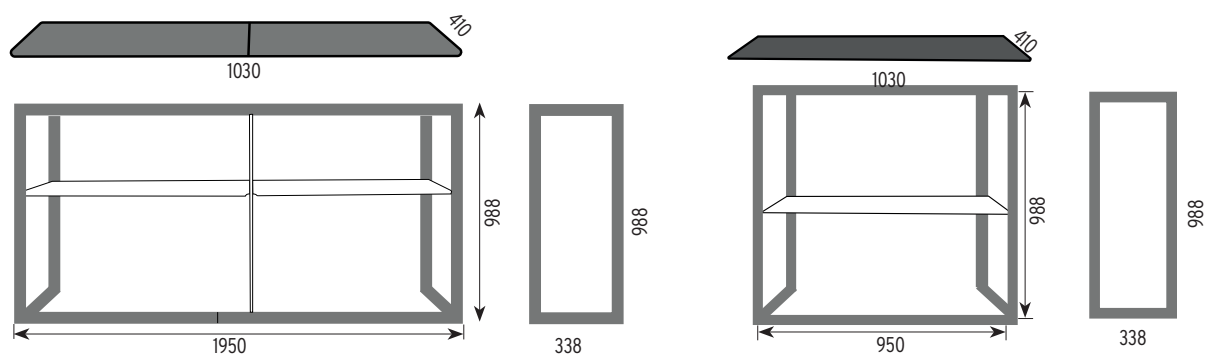

## Fabric Stand

| Product                     | Frame outer measurements | Weight |
|-----------------------------|--------------------------|--------|
| Fabric Stand with feet      | 996 x 1996               | 4,6    |
| Fabric Stand with flat base | 996 x 1996               | 6,1    |

Graphic size - frame outer measurements

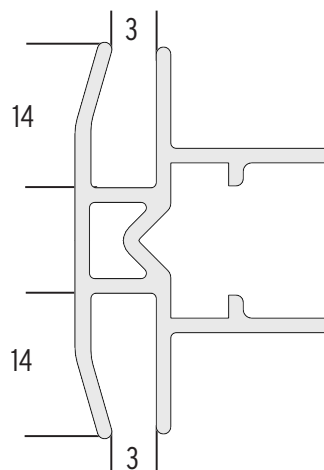
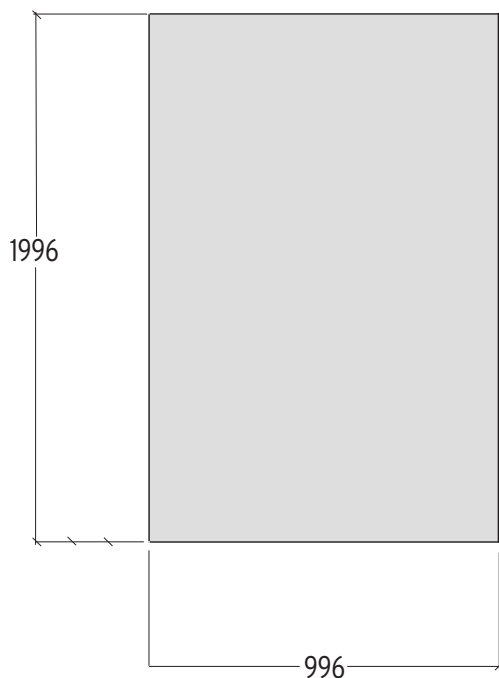

**Recommended max size for silicone or pvc list 14 x 3 mm**

## Monitor Stand

| Product       | Max screen weight       | System height | Weight |
|---------------|-------------------------|---------------|--------|
| Monitor Stand | 15 kg (about 55" today) | 1810 mm       | 14 kg  |

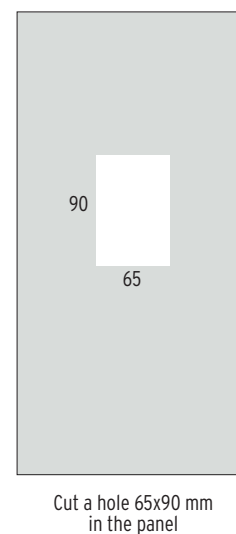
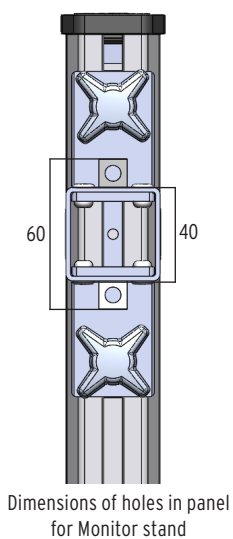
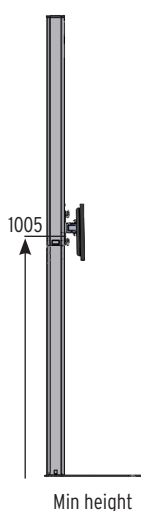
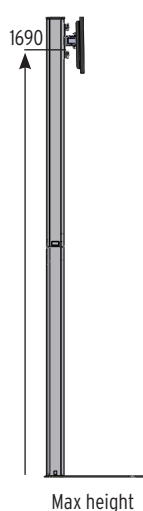

## Light Frame Mini

| Product                 | Frame outer measurements | Weight |
|-------------------------|--------------------------|--------|
| <b>Light Frame mini</b> | 1000 x 1987              | 8,5    |

Graphic size - frame outer measurements

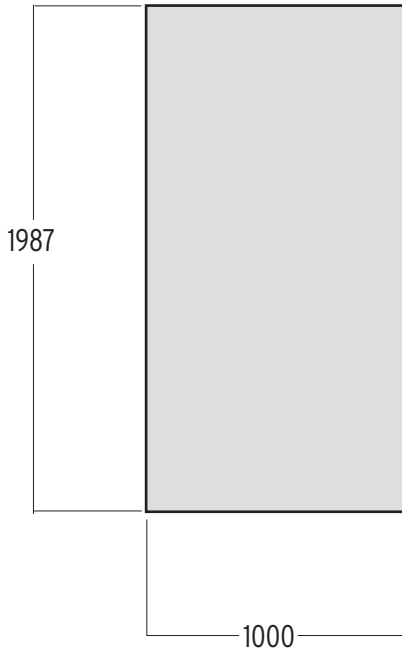

Recommended max size for silicone or pvclist 15x4 mm

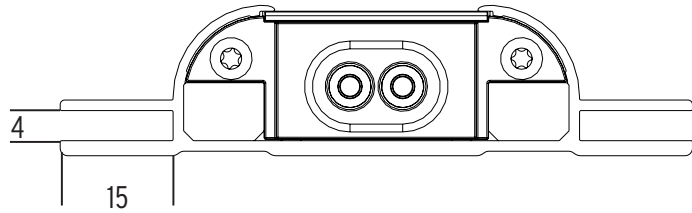

## Light Frame Counter

| Product                    | No of graphics | Outer frame sizes | Weight* |
|----------------------------|----------------|-------------------|---------|
| <b>Light Frame Counter</b> | 1 pc front     | 1001x1014         | 8,5     |
|                            | 2 pcs sides    | 304x1014          |         |

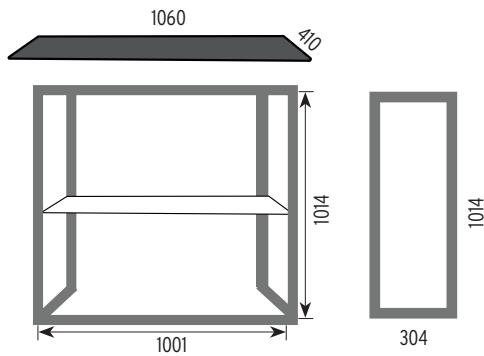

Recommended max size for silicone or pvclist 14 x 3 mm

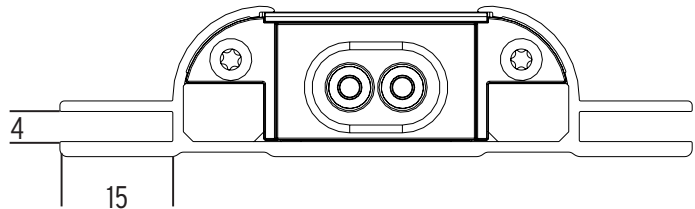



## Magnet Frame

| Product           | Art No | Panel size | Weight |
|-------------------|--------|------------|--------|
| <b>400 x 1600</b> | 6451   | 400 x 1585 | 2,9    |
| <b>610 x 1800</b> | 6454   | 610 x 1785 | 3,8    |

Recommended panel thickness 350x420 micron. 2 panels for double sided system.



## Magnet Frame with Flat Base (purchased 2020 or earlier)

| Product           | Panel size | Weight Flat Base | Weight Magnet Frame |
|-------------------|------------|------------------|---------------------|
| <b>400 x 1600</b> | 400 x 1585 | 1,1              | 1,8                 |
| <b>400 x 1800</b> | 400 x 1785 | 1,1              | 1,9                 |
| <b>610 x 1600</b> | 610 x 1585 | 1,7              | 2,0                 |
| <b>610 x 1800</b> | 610 x 1785 | 1,7              | 2,1                 |

Recommended panel thickness 350x420 micron. 2 panels for double sided system.

## Magnet Frame with Panel Base (purchased 2020 or earlier)

| Product           | Panel size | Weight Panel Base | Weight Magnet Frame |
|-------------------|------------|-------------------|---------------------|
| <b>400 x 1600</b> | 400 x 1535 | 1,7               | 1,8                 |
| <b>400 x 1800</b> | 400 x 1735 | 1,7               | 1,9                 |
| <b>610 x 1600</b> | 610 x 1535 | 2,5               | 2,0                 |
| <b>610 x 1800</b> | 610 x 1735 | 2,5               | 2,1                 |

Recommended panel thickness 350x420 micron. 2 panels for double sided system.

## Panel Base

| Product                     | Qty panels | Max panel thickness | Weight |
|-----------------------------|------------|---------------------|--------|
| <b>Panel Base 80 (pair)</b> | 1 pc       | 19                  | 0,7    |
| <b>Panel Base 400</b>       | 1 pc       | 19                  | 1,7    |
| <b>Panel Base 610</b>       | 1 pc       | 19                  | 2,5    |
| <b>Panel Base 1220</b>      | 1 pc       | 26*                 | 7,2    |

Panel Base can handle most materials up to 19 mm thickness. Recommended max panel height ca 1800 mm depending on the material.  
Please note that 50 mm at the bottom will be invisible in the systems L-extrusion.

### Panel Base 80



### Panel Base 400

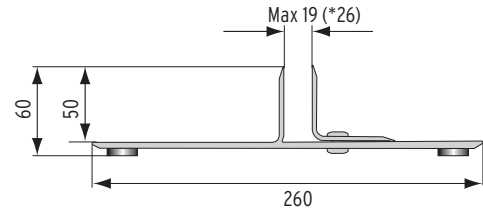
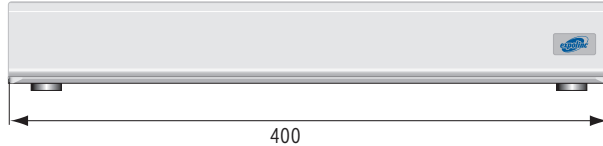

### Panel Base 610/1220

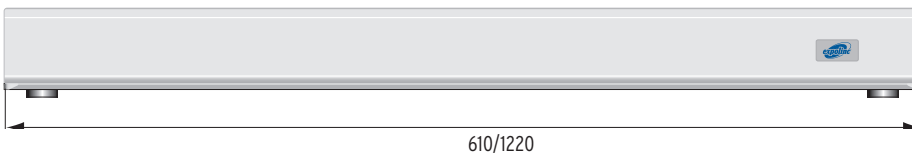

## Stand Up

| Product                  | Qty panels |       | Panel size | Visible size | Weight |
|--------------------------|------------|-------|------------|--------------|--------|
| <b>Universal Counter</b> | 1 pc       | Front | 700 x 950  | 690 x 940    | 17,5   |
|                          | 4 pcs      | Sides | 285 x 950  | 275 x 940    |        |
| <b>Info Counter</b>      | 1 pc       | Front | 700 x 950  | 690 x 940    | 9,5    |
|                          | 2 pcs      | Sides | 285 x 950  | 275 x 940    |        |

Maximum panel thickness 7 mm. Use clips in thickness <5 mm.

### Stand Up Universal Counter

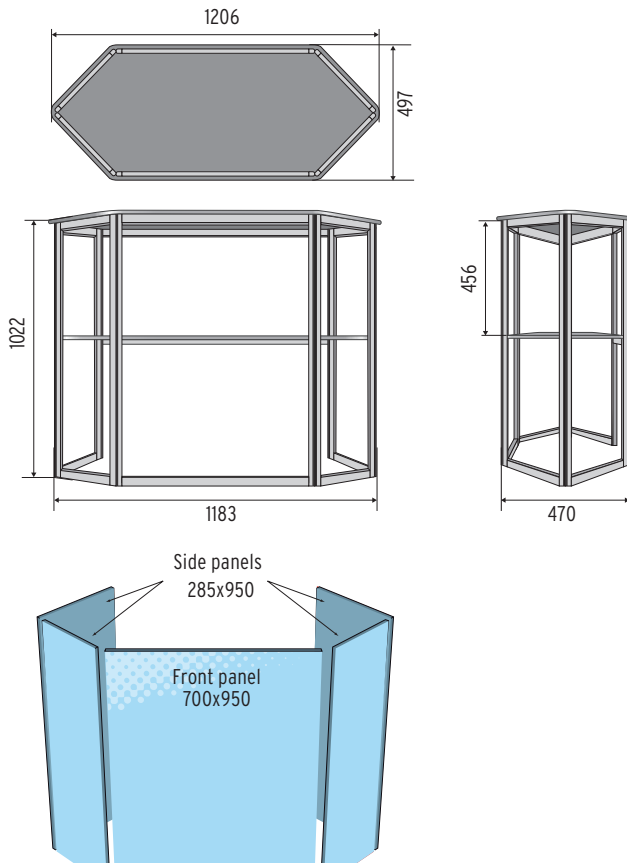

### Stand Up Info Counter

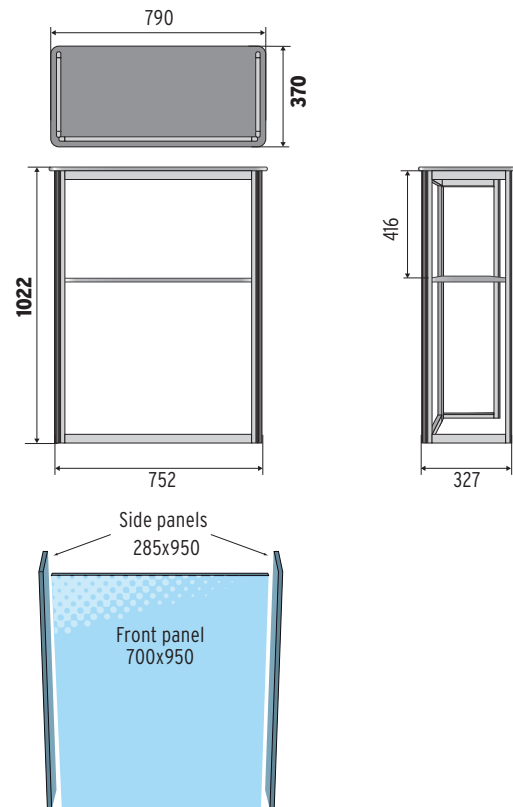

## Soft Image

| Product                 | Panel size front textile | Panel size covered sides | Weight* |
|-------------------------|--------------------------|--------------------------|---------|
| <b>Soft Image 2 x 3</b> | 1510 x 2240              | 2150 x 2240              | 7,0     |
| <b>Soft Image 3 x 3</b> | 2240 x 2240              | 2880 x 2240              | 9,2     |
| <b>Soft Image 4 x 3</b> | 2970 x 2240              | 3610 x 2240              | 11,14   |
| <b>Soft Image 5 x 3</b> | 3700 x 2240              | 4340 x 2240              | 13,6    |

\*Weight frame only. The above sizes are the actual sizes. As textile is elastic the size may vary.

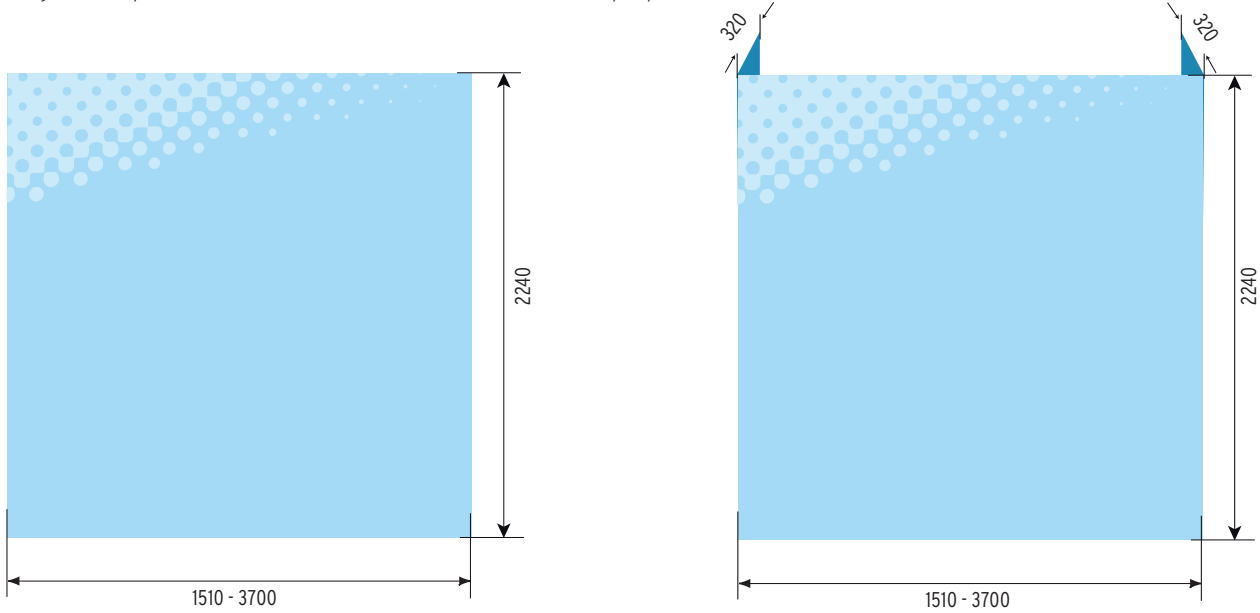

## Soft Image Counter

| Product                         | Size textile front and sides | Weight |
|---------------------------------|------------------------------|--------|
| <b>Soft Image Counter alt 1</b> | 1640 x 990                   | 10,5   |
| <b>Soft Image Counter alt 2</b> | 1740 x 990                   | 10,5   |

The above sizes are the actual sizes. As textile is elastic the size may vary.

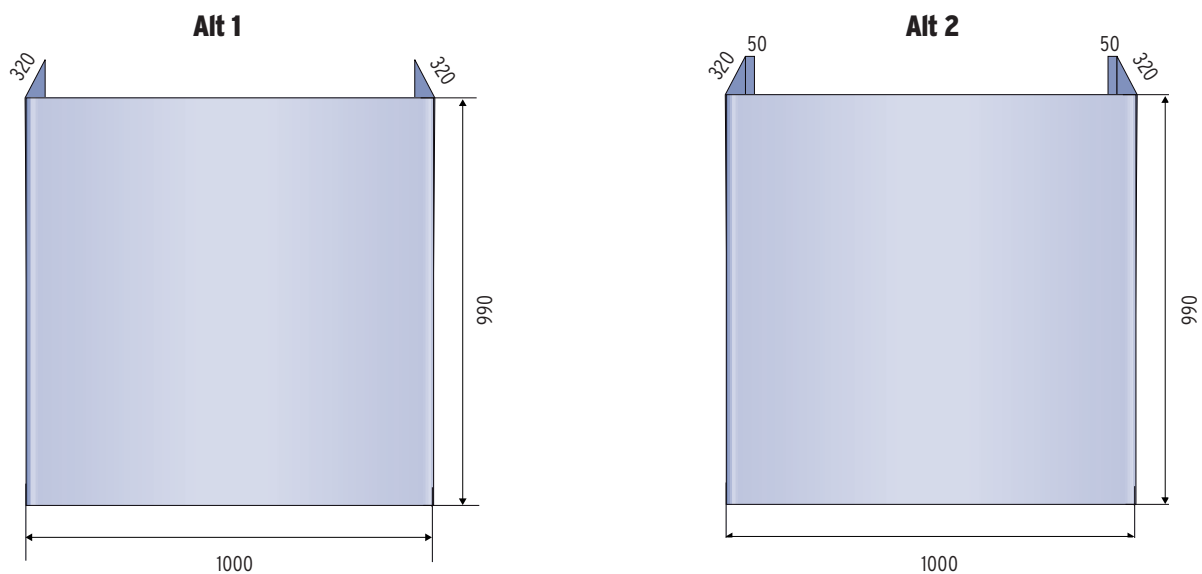

## Info Stand & Portable Table

| Product                      | Max image size  | Visible size  | Weight |
|------------------------------|---|---|--------|
| <b>Info Stand - straight</b> | 297x420 (landscape A3)                                    | 284x420   | 4,8    |
| <b>Info Stand - angled</b>   | 210x297 (portrait A4) <i>or</i><br>297x210 (landscape A4) | 210x297 (portrait A4) <i>or</i><br>297x210 (landscape A4) | 5,2    |
| <b>Portable Table</b>        |   |   | 10,0   |

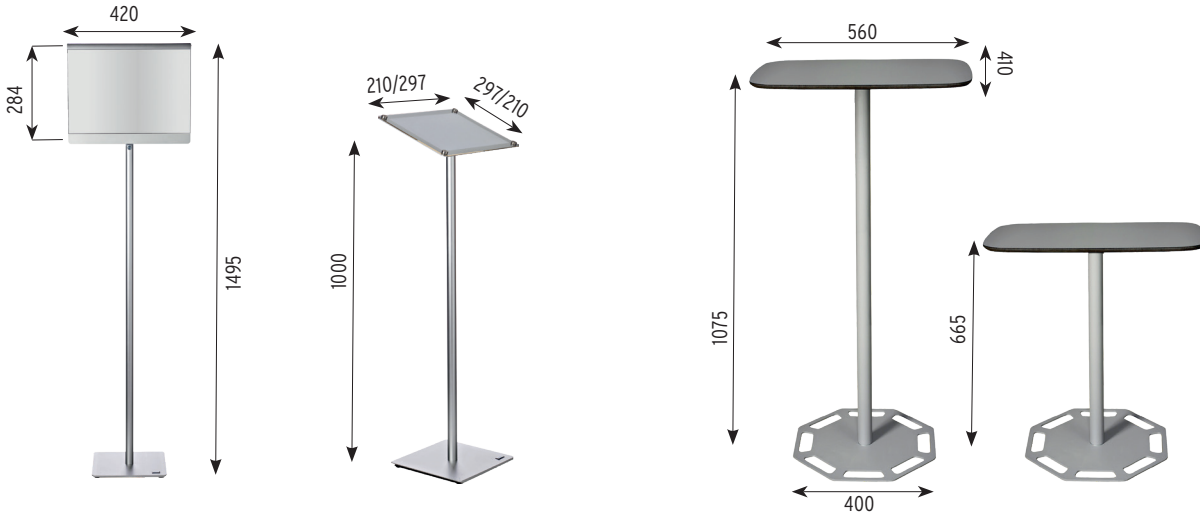

## Brochure Stand

| Product                              | Qty holders | Size of holder | Weight |
|--------------------------------------|-------------|----------------|--------|
| <b>Brochure Stand with soft bag</b>  | 4 pcs A4    | 220 x 330      | 4,9    |
| <b>Brochure Stand with hard case</b> | 4 pcs A4    | 220 x 330      | 8,4    |

## Brochure Stand Double

| Product                                     | Qty holders | Size of holders | Weight |
|---|-------------|-----------------|--------|
| <b>Brochure Stand Double with soft bag</b>  | 5 pcs A4    | 220 x 330       | 5,2    |
| <b>Brochure Stand Double with hard case</b> | 5 pcs A4    | 220 x 330       | 8,7    |

## Graphic Profile

| Product             | Max thickness<br>mikron | Weight<br>Kg/m |
|---------------------|-------------------------|----------------|
| <b>All versions</b> | 800                     | 0,35           |

VISIT [WWW.EXPOLINC.COM](http://WWW.EXPOLINC.COM) FOR SET-UP MOVIES AND DOWNLOADS



WATCH OUR SET-UP MOVIES



HEAD OFFICE SWEDEN: Expolinc AB, Archimedesvägen 6, SE-168 67 BROMMA. Tel +46-8-54644400. info@expolinc.se, www.expolinc.com  
GERMANY, SWITZERLAND: Expolinc GmbH, Schulze-Delitzsch-Str. 8, 68542 HEDDESHEIM. Tel +49(0)6203 938480, info@expolinc.de, www.expolinc.de  
U S A: Expolinc Co., PO Box 218, 1091 County Road 26, Marengo, OH 43334 TOLL FREE 1-800-319-0025. info@expolinc.us, www.expolinc.us  
AUSTRIA, CZECH REPUBLIC, HUNGARY: Tel: +43 660 644 0701, roland@expolinc.at  
FRANCE: Tel +33 (0) 6 59 47 98 54, denis@expolinc.com