



S ONE SERIES

Summa S One Series
Product Presentation

S One Series - Affordable high quality



S One D60

- 65 cm cutting width (ext. load)
- Optimised for rolls up to 67 cm
- Accepts media up to 67 cm wide
- Stand, basket are optional
- OPOS X is included

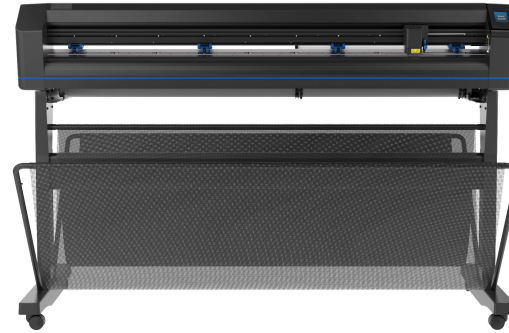

S One D140

- 142 cm cutting width (ext. load)
- Optimised for rolls up to 144 cm
- Accepts media up to 142 cm wide
- Stand, basket are included
- OPOS X is included

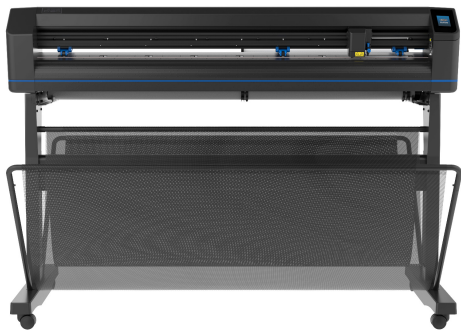

S One D120

- 128 cm cutting width (ext. load)
- Optimised for rolls up to 127cm
- Accepts media up to 127 cm wide
- Stand & basket are included
- OPOS X is included

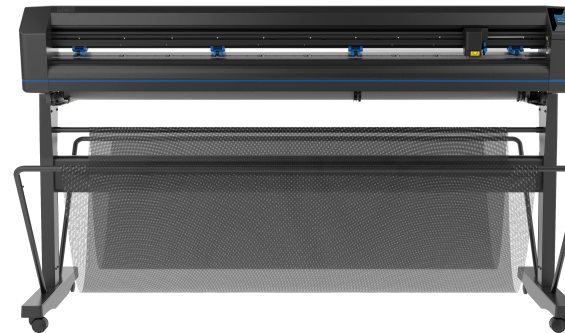

S One D160

- 162 cm cutting width (ext. load)
- Optimised for rolls up to 164 cm
- Accepts media up to 164 cm wide
- Stand & basket are included
- OPOS X is included



S One FX Series – S1 D140 FX

S One D140 FX

- 138 cm cutting width
- Optimised for rolls of 137 cm, 122 cm, 100 cm, 91 cm, 75 cm, 61 cm, 50 cm, 40 cm, 30 cm
- Accepts media up to 142 cm wide
- Stand and basket included
- Full OPOS functionality included
- Perfect match to any 138 cm (54in.) printer

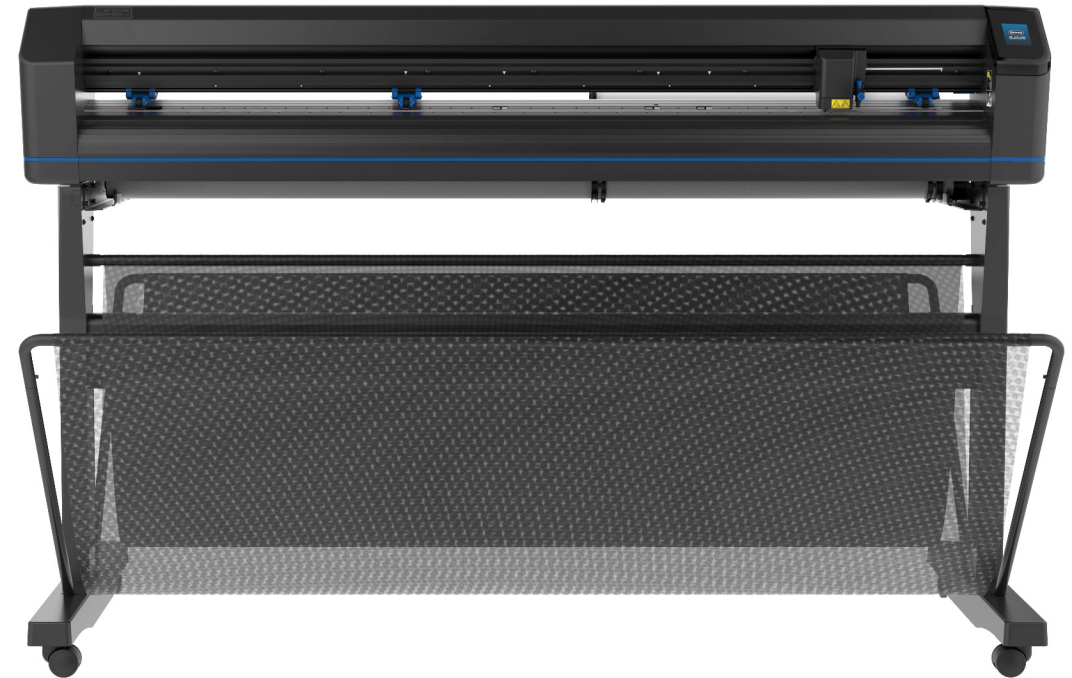

<i>D140 FX</i>	1	2	3	4	5	6	7	8	9
<i>Working width</i>	1324 mm	1174 mm	954 mm	864 mm	720 mm	570 mm	454 mm	350 mm	260 mm
<i>Target material width</i>	1372 mm	1220 mm	1000 mm	914 mm	762 mm	610 mm	508 mm	406 mm	297 mm



S One FX vs S One Series

- Flexible Working Sizes - FX has no wide grit roller
- Minimum size 26 cm vs 18 cm
- Less possibilities to cut scrap (important for direct cut)
- Any media size can be loaded but margins cannot be minimised(1)
- More material loss
- When contour cutting (OPOS), the extended mode (making it possible to work outside the pinch rollers), is automatically activated. Although limited, cutting and placing of the OPOS marks in the extended zone is possible, minimising material loss
- The loss of working size flexibility of the FX is minimal when contour cutting
- Velocity – Although the FX model has the same maximum specifications(2) it will need about 25% more time to finish the job.
- Target for FX units are customers with a low workload. Only some of these customers' printed jobs will need contour cutting. The direct cut method is not their focus working method.
- Notes
 - (1) Extended mode can minimise margins but with limitations
 - (2) Throughput not only depends on velocity and acceleration but also on the up/down speed of the head, the possibility to combine maximum specs, and the performance reductions due to material weight or curve complexity.

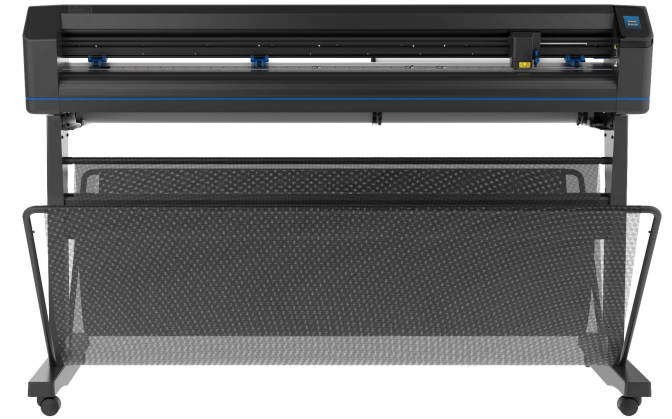

S One D140FX

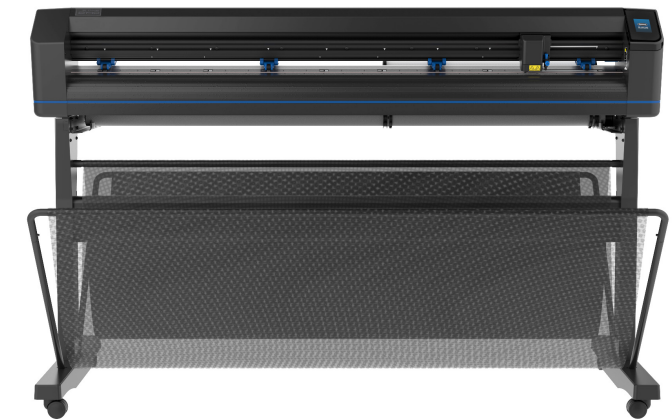

S One D140

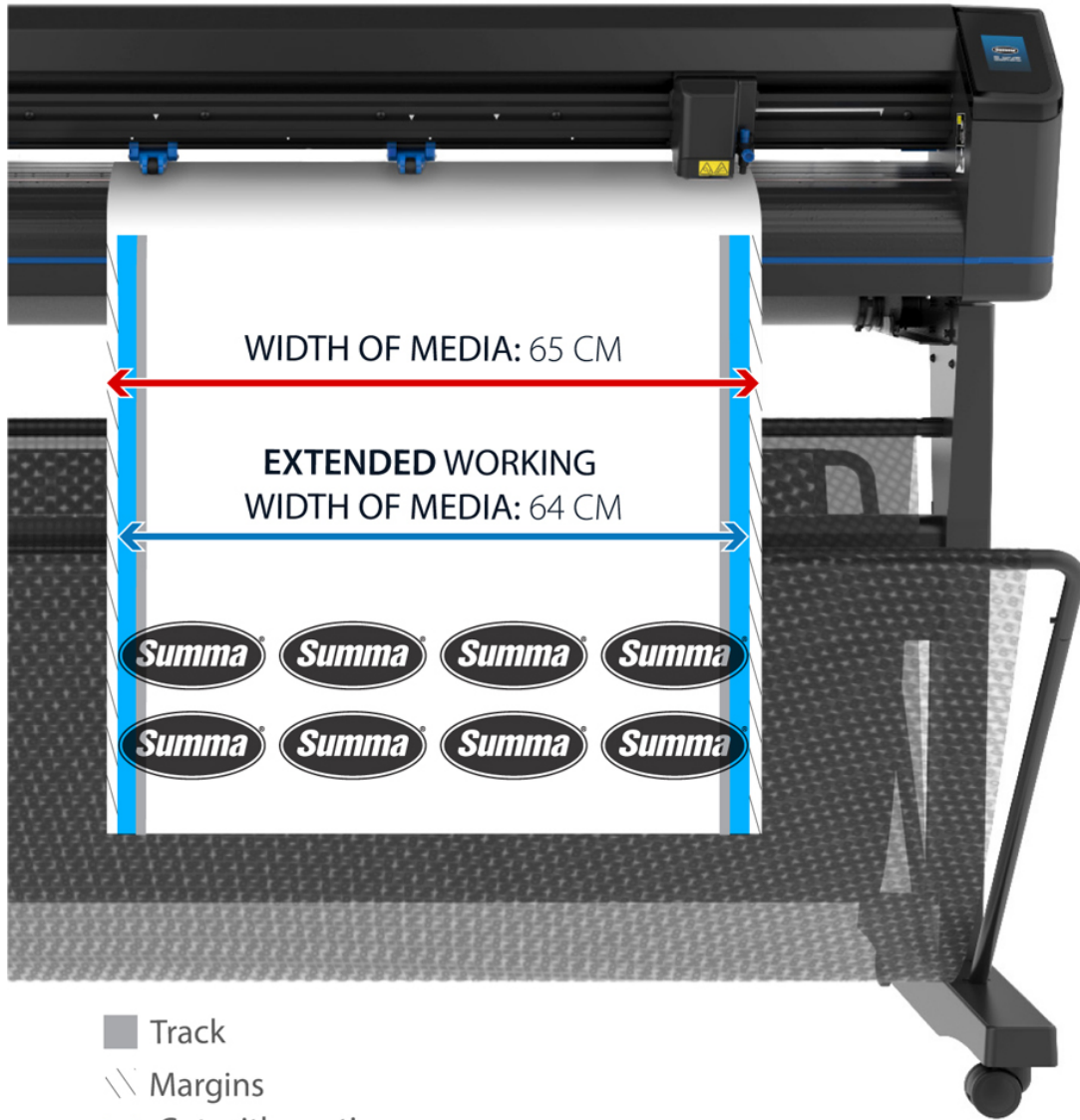

- Track
- \\ Margins
- Cut with caution
(FlexCut discouraged, tracking not guaranteed)

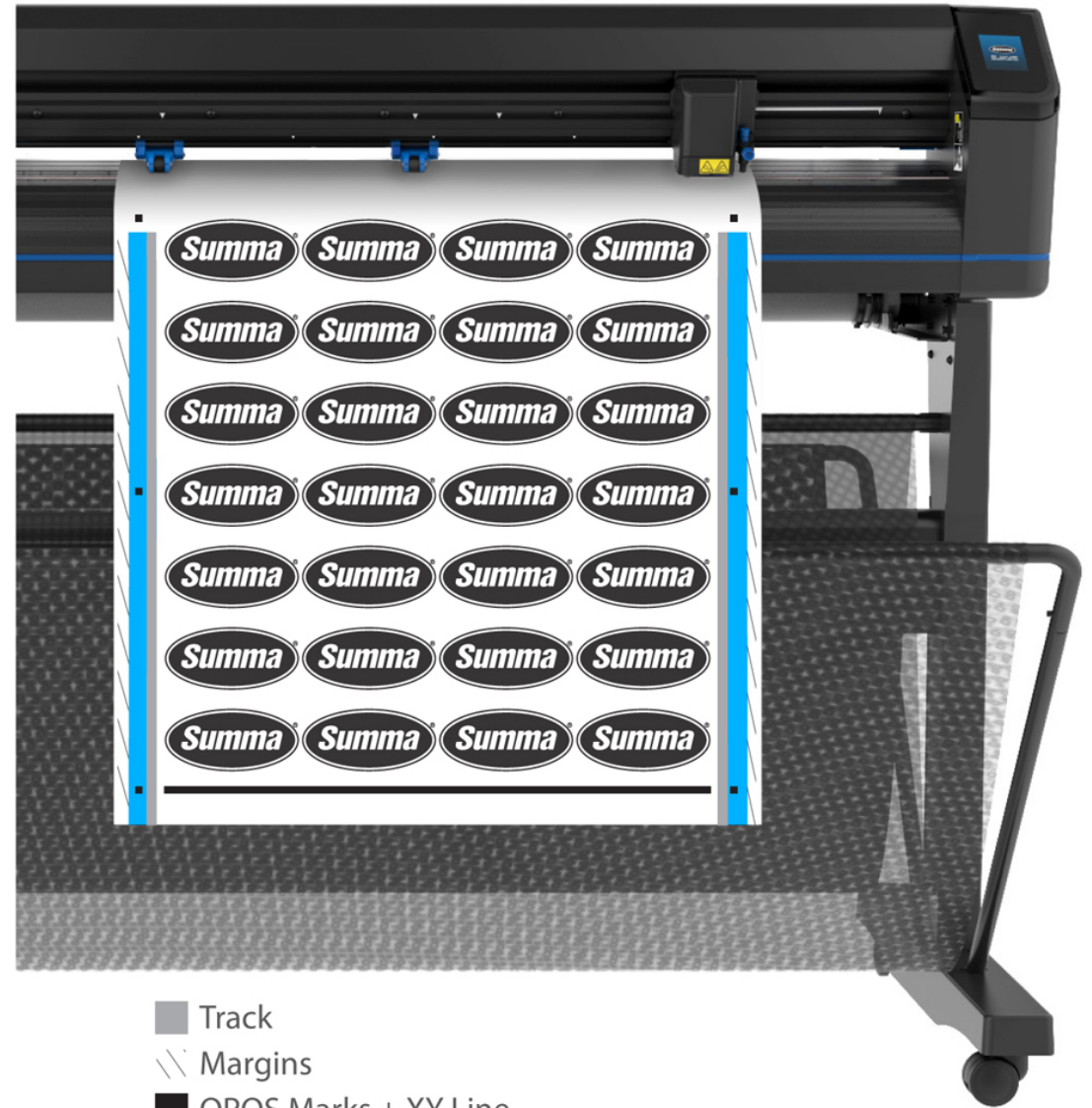

- Track
- \\ Margins
- OPOS Marks + XY Line
- OPOS Marks allowed



Key features

Quality

- Summa is renowned for its durable cutting machines. Quality is a major concern of the entire Summa team. With more than 15 years of experience in building cutting plotters, Summa delivers products that are reliable and durable. But not only the product itself, also the output needs to fulfill Summa's quality levels, which are one of the highest on the market.
 - Design & Development / Production / Delivery / After Sales Support

Functionality

- Cutting vinyl is the main job on S One roll cutters. Therefore, Summa developed the S One cutter in order to fulfill this need in all its aspects. The S One cutter is your companion if you want to perform long jobs, if you want the job to be done in time and if you want a perfect cut without any hassle. The S One cutter offers you all this and more. Even cutting around pre-printed jobs is possible.
 - Drag Knife Cutting Head / Material Handling / Internal Intelligence / Software / Contour Cutting

Compatibility

- Summa vinyl cutters are popular around the world. In this regard, drivers are included with almost every sign making package. The S One cutters come with all the tools necessary to connect your system quickly and easily.
 - Connectivity / Software / GoSign / MacSign / Drivers

**S ONE
SERIES**



Quality

- For Summa, quality is not just a statement. It is an attitude throughout our complete organisation. As actions speak louder than words, Summa includes a two-year warranty* with all its products.
- Of course, many competitors can deliver an acceptable cutting quality. But can they also do it over 8 meters long ? At full speed ? After hours of cutting at full speed ? After years of intensive use? The S One cutter fulfills all the above criteria. What's more? We guarantee it! We guarantee it because every S One cutter is built and tested to do so.

* The warranty on Summa products can locally be extended. Please contact Summa for more detailed information. The two-year warranty is on parts only.

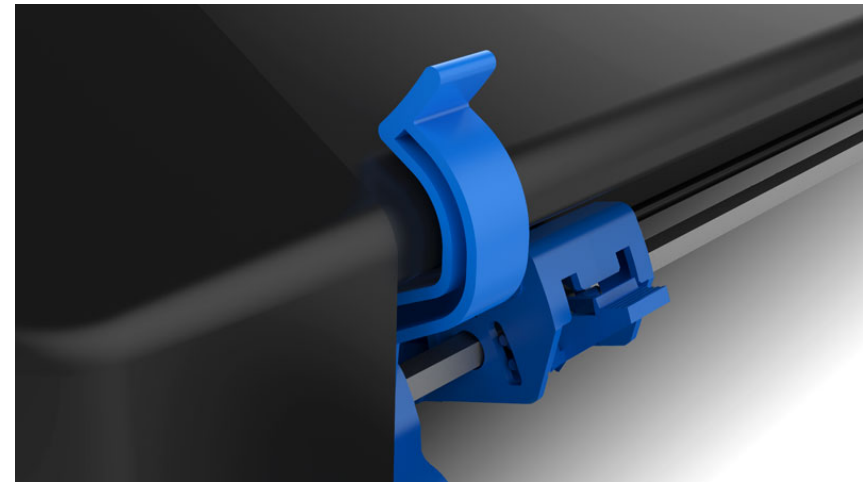

Functionality

- The S One's basic goal is to cut vinyl in a straightforward and reliable way. However, a lot of features can make life a lot easier and allow you to do more than 'just' vinyl cutting.
- For Summa, meanwhile many features are evident. However, we continuously experience that features which have been included in our product for many years are still not available in competitive products.

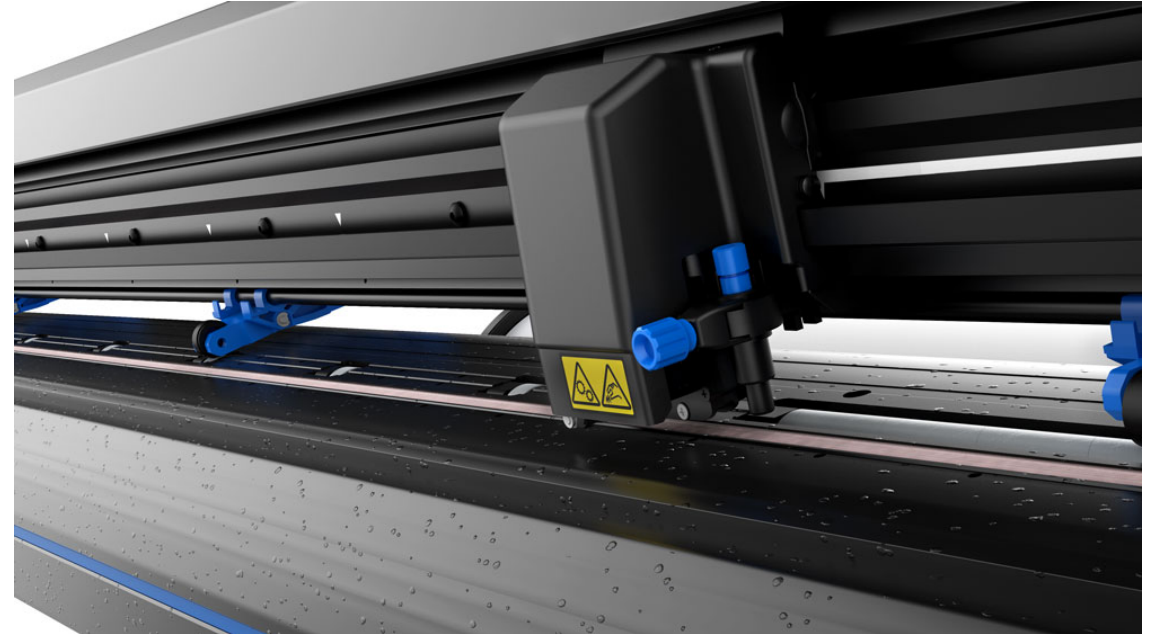

Drag Knife Cutting Head

- The drag (or swivel) technique is the most common on the market. The most important benefit is its simplicity and reliability.
- The S One's versatile cutting head allows for quick switches between standard blades, thick material blades, plotting pens or pouncing tools to create perforated templates.
- With up to 600 grams of cutting force, the affordable S One cutter outperforms many manufacturers' high-end cutters. We would like to emphasize that our cutting head is built and tested to sustain these high pressures. These 600 grams is, therefore, not just a peak value! With the optional sandblast knife, materials up to 0.8 mm thick can be cut.
Note: the 140FX version has 400 grams of cutting force
- Advanced Summa internal programming delivers quality and versatility, which cannot be found in any other drag-knife cutter. Our exclusive OptiCut™ feature eliminates flaws due to knife wear. The FlexCut feature enables cutting through paper, cardboard and even vinyl.

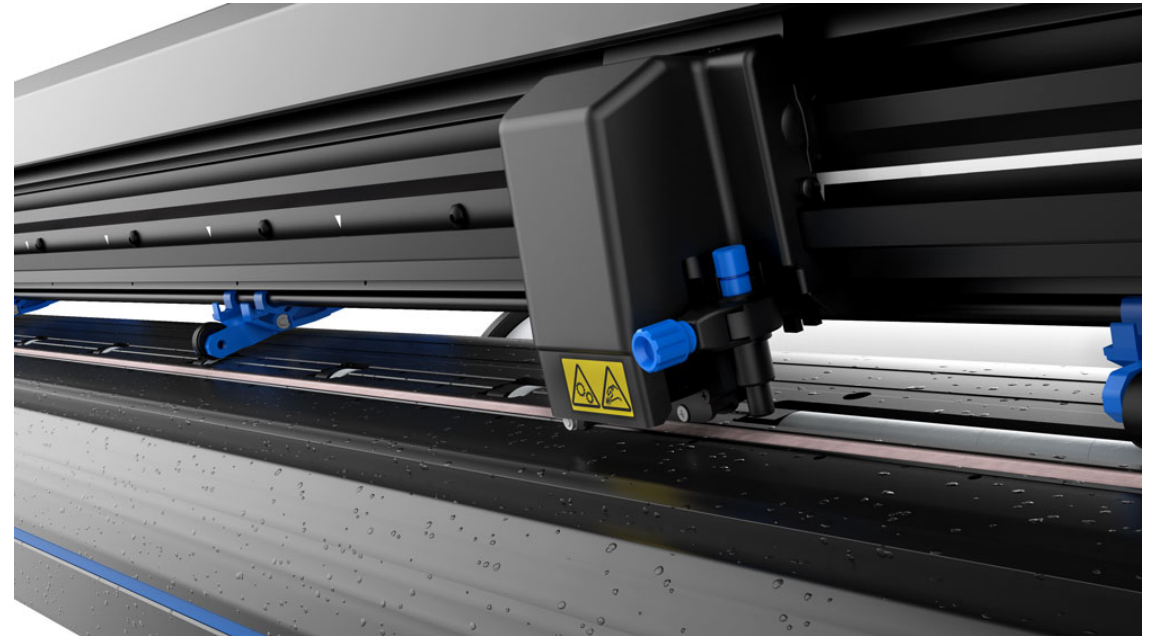

Material Handling

- Material transportation is probably one of the most important issues when cutting vinyl. The slightest error can result in waste of vinyl, loss of time and frustrated operators. Summa spends a lot of time and money to make sure your S One cutter performs perfectly and flawlessly. The exclusive MicroSprocket™ drive drum tracks full rolls without skewing off-track. Complete cutting accuracy on individual files is guaranteed up to 8 meters in length, enabling to cut long designs or various designs subsequently without the need to reload. The very durable titanium coated grit rollers assure you can work intensively for many years with the best tracking system available on the market.
- All Summa cutters can be fully adjusted to load a roll from any width between the minimum and maximum size. This way, all scrap can be used with minimal margins.
- Integrated adjustable media rollers and media roll-end flanges keep your vinyl on track, even when cutting at top speed.
- As the media advances, the output is collected neatly in a mesh basket(2), thus preventing dust and debris from collecting onto the media. This eliminates the problem of media ending up on dirty floors, which can contaminate work surfaces and which might result in particles being trapped between the vinyl and the substrate. The basket also neatly organises the vinyl and other media when processing longer jobs.

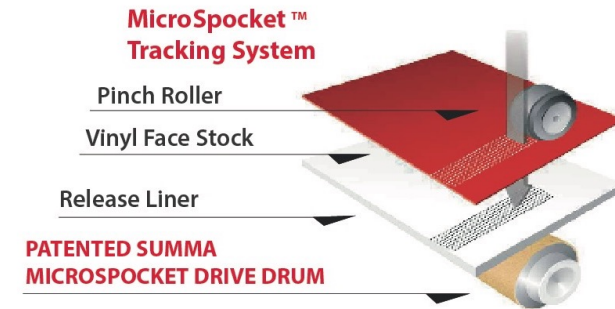

FlexCut

- Summa's FlexCut feature makes it possible to perforate media, enabling to push out the design from its carrier. Alternating, one length is cut completely through the media, and one length is cut half through. This way a kind of tear-off line is created, which makes sure the carrier keeps a certain rigidity during transportation through the cutter. At the same time it is easy to take out the design afterwards.

Summa's FlexCut feature includes optimisations and increases reliability for the use on a wide range of materials.

- To use FlexCut, you don't need to switch the knife position because everything is handled by the internal programming.

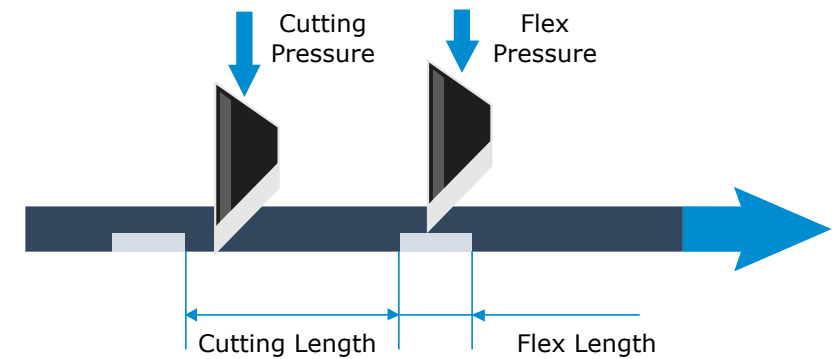

Performance

- The S One cutter is equipped with servo motors.
- All S One cutters use an advanced vector look-ahead technology that cuts complex images and font types with improved efficiency. The unique Overcut feature makes weeding easier, accelerating your sign making projects at every phase of production.
- The S One cutter is based on the proven knowledge of the Summa developed cutters (SummaSign / SummaCut / S Class), combined with up-to-date techniques and years of experience.
- State-of-the-art engineering, sophisticated software programming and versatile enhancement options have been combined to deliver unmatched performances.
- The TurboCut™ technology increases drag knife throughput up to 40%.

S ONE
SERIES



Internal Intelligence

- The S One cutter is loaded with several intelligent routines, optimising the cutting data. The S One cutter is based on the proven knowledge of the Summa cutters. Together with the most recent techniques and years of experience the S One cutter has become a cutting plotter that holds a leading position in the market.
- All S One cutters use an advanced vector look-ahead technology that cuts complex images and fonts with improved efficiency. The benefits are extensive. The cutting time is reduced considerably. Curves are smoother, and the motors are less loaded, which increases the lifespan of the cutter.
- The Overcut feature makes weeding easier. While the OptiCut feature, which simulates tangential cutting, compensates knife wear. More routines such as 'smoothing', 'concatenation' or 'bundling' enable to recalculate and improve the cutting data. This is very important if your software is not optimised to cut.

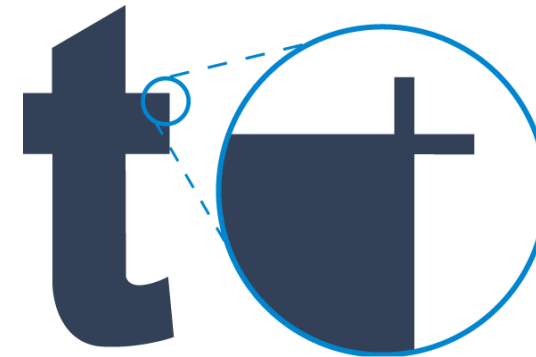

OverCut



Without OptiCut

With OptiCut

5 mm character

Contour Cutting

- Although durability of digital prints has improved noticeably over the last few years, lamination is still mandatory in order to protect the output from scratches, impacts and other mechanical aggressions. The lamination can also provide additional UV resistance or a glossier finish to the print. A real nightmare for most optical sensors, used for automated contour alignment.
- Using different registration mark colours is not an issue for Summa's new OPOS X sensor which is very sensitive and operates in a wide spectrum of light. The OPOS X sensor even detects registration marks through a dense floor graphics laminate with uneven texture.
- All S One cutters are equipped with the OPOS X sensor technology, which brings contour cutting to a higher level.
- Summa's alignment methods include:
 - OPOS X
 - OPOS XY
 - OPOS XY2
 - OPOS Barcode
 - OPOS Xtra

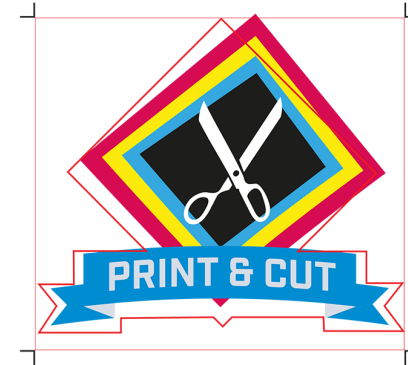

Without OPOS

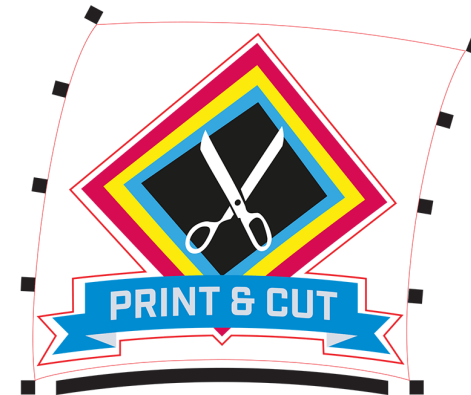

With OPOS

Contour Cutting – OPOS X

- The OPOS X technology, standard on all S One models, looks automatically for the cross marks by using a sensor. OPOS X has extended possibilities to execute contour cutting jobs automatically, fast, accurately and on a wide range of materials. The possibility to use multiple cross marks is a unique OPOS feature and guarantees the best possible accuracy. The multiple-job options enable the S One cutter to handle several jobs subsequently with minimal user intervention, if needed at all.

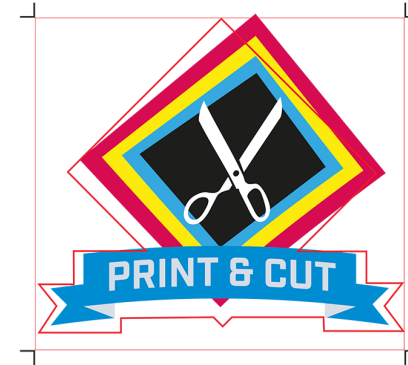

Without OPOS

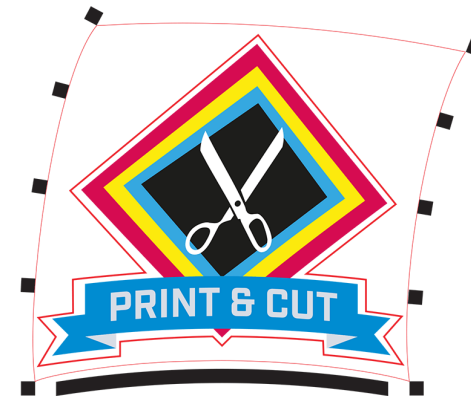

With OPOS

Contour Cutting – OPOS XY- XY2

- OPOS XY was already part of the OPOS alignment methods. This feature allows to measure a line across the print width, additionally to the OPOS marks. This will automatically adjust media curvature or deformation across the width of the print.
- OPOS XY has been enhanced using the OPOS XY2 alignment method, adding an additional measurement line at the rear of the print. This additional line allows to compensate for any changes in print curvature between start and finish of your print job.

OPOS XY2

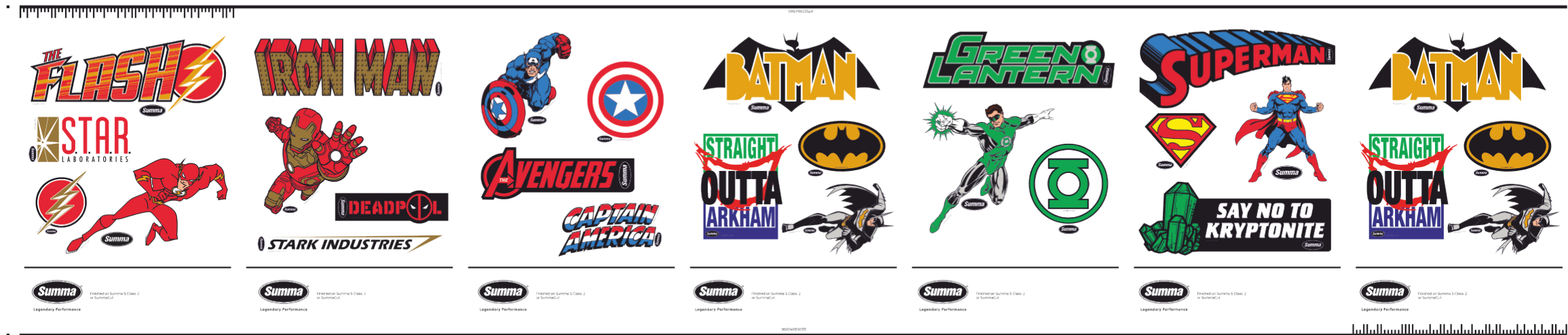

OPOS XY



Summa S One Series
Product Presentation

OPOS X - Barcode

- The barcode reading functionality is a productivity tool
- It is available on all S One Series
- Every job has its own unique job number indicated by a barcode in the front of the job
- The OPOS X sensor reads the barcode and sends the job number to the computer
- The computer returns the matching cutting information which is processed by the cutter
- When the job is finished the cutter automatically starts looking for the next job and its barcode
- This way multiple jobs can be processed without the operator's intervention. Also, the risk of sending the wrong data to the wrong print no longer exists.



Contour Cutting – OPOS Xtra

- A next evolution in OPOS is OPOS Xtra. This alignment mode is designed to handle irregular material deformation over the length of the print by adding additional XY lines between the designs. This increases the accuracy and alignment methodology for smaller stickers.



Compatibility

- Nothing is more frustrating than having a fully featured cutter but not being able to use it. Summa, therefore, offers the necessary tools to connect your S One cutter to your system.
- GoSign is complimentary with every S One cutter
- The S One cutter has two communication ports (Ethernet and USB) to make sure you can set up a reliable hardware connection
- Summa has several drivers to support the S One cutter on different platforms
- Summa has unique tools to control your S One cutter from your computer



Connectivity

- Summa was the first manufacturer to integrate a full-fledged USB port (Universal Serial Bus) on its vinyl plotters. This represents yet another proof of Summa's technological leadership. Thanks to the USB port and the ethernet port, the S One cutter can be connected to most common computers on the market. A 5 meter long USB cable is included.
- The USB port is version 2.0 and supports high-speed bi-directional communication. The port is hot-pluggable meaning that as soon as you connect the cutter, the computer will recognise the device. The USB is fully supported by all current windows versions.
- All S One models are equipped with an Ethernet port, which provides connection of multiple computers in a Local Area Network (LAN).
- Additionally, a WiFi connection is available on all units in case a wired Ethernet connection is not possible.
Note: WiFi is unlocked after registering your device and is only available for European countries, the US and Canada.



Control Software

Summa Cutter Control is a unique tool that controls your S One vinyl cutter. It can read and control all settings of the cutters. It is a remote keyboard on the computer.

- Summa Cutter Control can save your settings on the hard disk. This enables to further expand the 4 internal configuration settings for different types of jobs.
- Summa Cutter Control can calibrate the media in both the X and Y direction.
- Summa Cutter Control has several service capabilities, making support over telephone easy and straightforward.
- With Summa Cutter Control your cutter can be updated easily with the latest internal programming, which can be downloaded for free from the [Summa website](#).

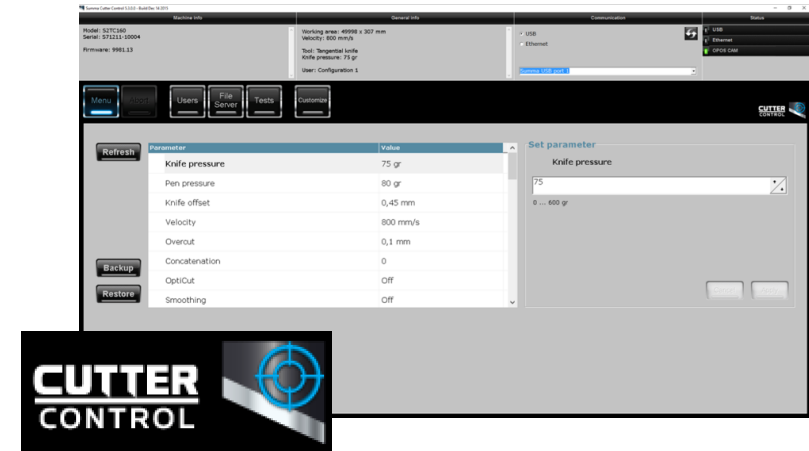

GoSign Workflow

GoSign is included free of charge with all Summa roll cutters. This software enables to import PDF, SGP, OXF and DXF files. It scales, rotates and prepares the design for cutting. GoSign can add a weeding box and it can also automate certain tasks you to make your designs ready to cut. Gosign software includes the following features.

- Material manager to save various material settings such as speed, pressure, camera profile for OPOS CAM
- Ability to create your own action sets to automate workflows
- Available in several languages: English, German, French, Italian, Spanish, Polish and Dutch
- Available as a plug-in for CorelDRAW & Illustrator
- Capable of controlling multiple Summa devices simultaneously
- Network-friendly and able to function similarly to any other network printer
- Able to cut based on colours
- Includes support for Summa's dual cut feature, which combines the Kiss-Cut and FlexCut feature in one job
- Includes the sorting functionality to increase productivity



- The extra DXF import filter makes GoSign a handy software for CAD users
- GoSign recognizes OPOS marks, ensuring the required information is sent to the cutter to activate the system
- PLT file reading, enabling to use and adapt pre-generated plt cut files
- Pro Pack: Hot folder system, to drop cut files in a hot folder and automatically send them to the cutter. This system also allows you to add certain action to the job before output
- Pro Pack: OPOS CAM Twin workflow, combining the strengths of an OPOS X (standard) roll cutter and a Summa flatbed cutter in one single workflow (not applicable on S One)
- Pro Pack: Barcode functionality, enabling to modify cut files and optimise cutting requirements



MacSign

MacSign Cut is a collection of plug-ins and functions for Adobe Illustrator. The functionality added includes a direct output from Illustrator towards your roll cutter.

- The ability to add OPOS marks to your design and output this as a cut file for printed material, including OPOS marks.
- Download the software bundle on www.summa.com in the Support and downloads section and register on the [SofTeam Website](#). The registration is required to make full use of the MacSign software and to receive a license key.
- For Mac OSX (10.6 – 10.15) : included with every Summa cutting plotter.

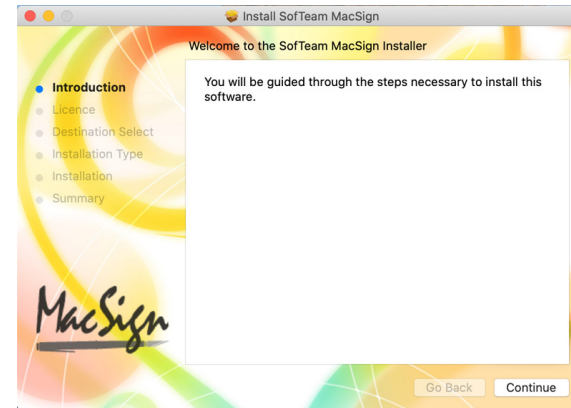

Drivers

The S One cutter understands a multitude of cutting languages, making it easy to interface with vector-based software.

- Upgrading your old Houston Instruments, SummaGraphics or Summa vinyl cutters is a piece of cake as our current machines are still compatible with the old drivers
- In case your software doesn't have a Summa driver, the S One cutter also accepts an extensive subset of HPGL and HPGL\2 commands.
- All Summa cutters include a native control language, enabling to read and change all parameters via the computer.
- This kind of open architecture ensures sign making programs can develop user-friendly interfaces and drivers for our products.
- Summa cutters are supported by all major sign making packages, both on PC and on Macintosh platforms. To receive updated information, please contact Summa or the software manufacturer.

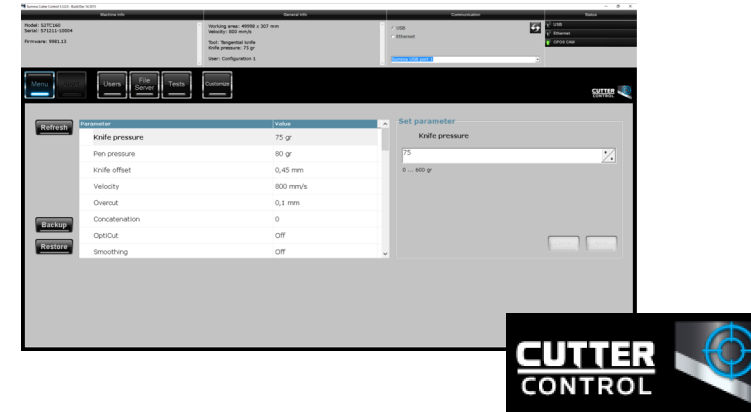

Target Markets

The target markets can be categorised by the usage of different types of materials:

Vinyl

Vinyl cutting is, of course, the main application on the S One Series. But not only the traditional sign maker is cutting vinyl. Increasingly more industries integrate vinyl cutters into their production workflow and reap the benefits of it.

Textile

After vinyl, flock and flex materials are probably the secondly most used materials. Continuous improvement of durability of flock material and the growth of customisation in the textile market reflect the importance of these material types.

Sandblast

Cutting sandblast foils used to be processed exclusively by heavy-duty tangential machines. Today, the sandblast foils have been developed in such a way even the S One Series can handle a wide range of these foils.

Others

Customers can be quite inventive. So, on a regular basis we receive requests to cut the most diverse materials. In most cases, Summa can provide a solid cutting solution to process a multitude of innovative materials.



Vinyl

Increasingly, people start to cut vinyl. Not only the traditional sign maker but also other industries enjoy the benefits of a user-friendly vinyl cutter. Moreover, the price of the machine dropped over the last years. The ease of use, the pricing and simplicity of graphical software packages have enlarged the diversity of S One users.

- Shopping chains, local authorities or larger companies produce sign making in-house for their indoor and outdoor decorations
- Businesses that were already active in the graphical market such as copy shops, screen printers, stand constructors, and so on offering extra sign making services to their customers.
- Companies with a large fleet maintaining their fleet-marketing with in-house sign making, which makes them more flexible to react on temporary promotions
- The in-house use of a vinyl cutter to create product labels results in a more flexible production planning
- The growing contour cutting possibilities make the S One cutter an attractive investment for screen printers because it saves the mold cost for die cutting. This is especially beneficial for smaller production runs.



Textile

Textile is a growing market. Requests increase for custom labelling to promote events, brands, sponsors, etc. Flock and Flex materials are a cheap and durable solution for small batches.

- The most significant application is sportswear. In major sports competitions, T-shirts are made for one simple game only (e.g. because an extra sponsor is added)
- All kinds of promo teams are wearing clothes made for just one event. The increasing requirements for customisation or personalisation enlarges the sales of the S One in this segment significantly
- Summa's cutting plotters are popular in the apparel market to cut stencils of clothing designs in thin cardboard paper. This is a totally different application, but it indicates that the textile market is truly a market to focus on.



Sandblast foil

- A wide range of masking materials for the sandblast industry can be cut with our drag knife cutting head.
- Sandblast material varies in thickness and strength, depending whether the application is done on glass, wood, stone, etc. With the optional knife and knife holder for thick material, materials up to 0.8 mm thickness can be cut. However, not all materials of less than 0.8 mm thickness can be cut. Material types thicker than 0.8 mm will undoubtedly result in inferior quality.
- With up to 600 grams of cutting force, the affordable S One cutter outperforms many manufactures' Pro cutters. We would like to emphasize that our cutting head is built and tested to sustain this high pressure. The 600 gram is, therefore, not just a peak value.
- Especially when cutting sandblast foil, Summa's extensive drag movement, which simulates a tangential movement, proves its benefits.



Standard delivered

USB cable (#399-111)



2x Standard knife



Power cord (EU and US)



1x Cut Off knife (391-290)
(+ replacement knife)



Pair of flanges (391-510)



Multilingual Quickstart & Assembly
guide



Spare fuse



Optional (*)

Standard knife holder
(391-332)



Stand and basket for S1D60
(393-1125)



(*) Stand and basket are included with S One D120, D140, D140FX & D160 units



Summary – S One Series

<i>Model</i>	S1 D60	S1 D120	S1 D140	S1 D160
<i>Width</i>	60 cm Drag Knife	120 cm Drag Knife	138 cm Drag Knife	160 cm Drag Knife
<i>Media width</i>	Rolls: 8 to 70 cm Sheets: 7 to 67 cm	Rolls: 14 to 135 cm Sheets: 14 to 135 cm	Rolls: 19 to 150 cm Sheets: 19 to 150 cm	Rolls: 19 to 169 cm Sheets: 19 to 169 cm
<i>Cutting area</i>	61 cm x 50 m	127 cm x 50 m	141 cm x 50 m	161 cm x 50 m
<i>Tracking performance</i>	Within +/- 0.1 mm (0.004 in.) on plots; up to 8 mm on rolls up to 760 mm wide up to 4 m on rolls over 760 mm wide			
<i>Speed</i>	Up to 113 cm/sec diagonal			
<i>Acceleration</i>	Up to 3 G diagonal			
<i>Knife pressure</i>	0-600 grams, in 5 grams increments			



Summary - S One FX Series

<i>Models</i>	D140 FX
<i>Width</i>	138 cm Drag knife
<i>Media width</i>	137 cm, 122 cm, 100 cm, 91 cm, 75 cm, 61 cm, 50 cm, 40 cm, 30 cm
<i>Tracking performance</i>	Within +/- 0.1 mm (0.004 in.) on plots; up to 8 m on rolls up to 760 mm wide up to 4 m on rolls up over 760 mm wide
<i>Speed</i>	Up to 113 cm/sec diagonal
<i>Acceleration</i>	Up to 3 G diagonal
<i>Speed</i>	0-400 grams, in 5 grams increments





Legendary Performance

CONTINUOUS IMPROVEMENT

www.Summa.com | [#SummaFinish](https://twitter.com/SummaFinish)